



4- Piston Caliper Big Brake Kit Installation Instructions

For: Austin - Healey BJ8 from (c)26705-on

PART # 586-725

440 Rutherford St. Goleta, CA 93117

1-800-667-7872 • FAX 805-692-2525 • www.MossMotors.com

Tools required:

- 10mm, 7/16 & 9/16 flare nut wrenches
- 9/16, 5/8, 3/4 & 10mm combination wrenches
- Catch can or pan
- Fresh brake fluid
- 1/2, 9/16, 5/8, 1-1/8 sockets and ratchet
- Vise grips
- Slide hammer
- Grease Cup Puller Tool (Moss # 384-935)
- Side cutters
- Rubber mallet
- Service manual

NOTE:

Verify your wheel bearings are in good condition before installation of this kit. Refer to the service manual. There should be zero end float of the hub and bearings. Looseness or end float in the bearings will cause the rotor to contact the brake caliper. Replace and properly set up/shim your bearings prior to the installation of this kit.

The brake rotors in your kit may look different than in the figures below. This does not affect function or installation of your kit.

- 1) Lift the car and place it on four strong, stable jack-stands. Take off the front wheels.
- 2) Disconnect the soft brake line from the hard brake line connection at the front left side of the car. Use a 9/16 flare nut wrench on the lower nut and a 9/16 combination wrench on the nut above the bracket. Use a provided black rubber stopper to stop the brake fluid from flowing out of the hard brake line. Then use two 9/16 combination wrenches to remove the line from the bracket. Refer to Figure 2.

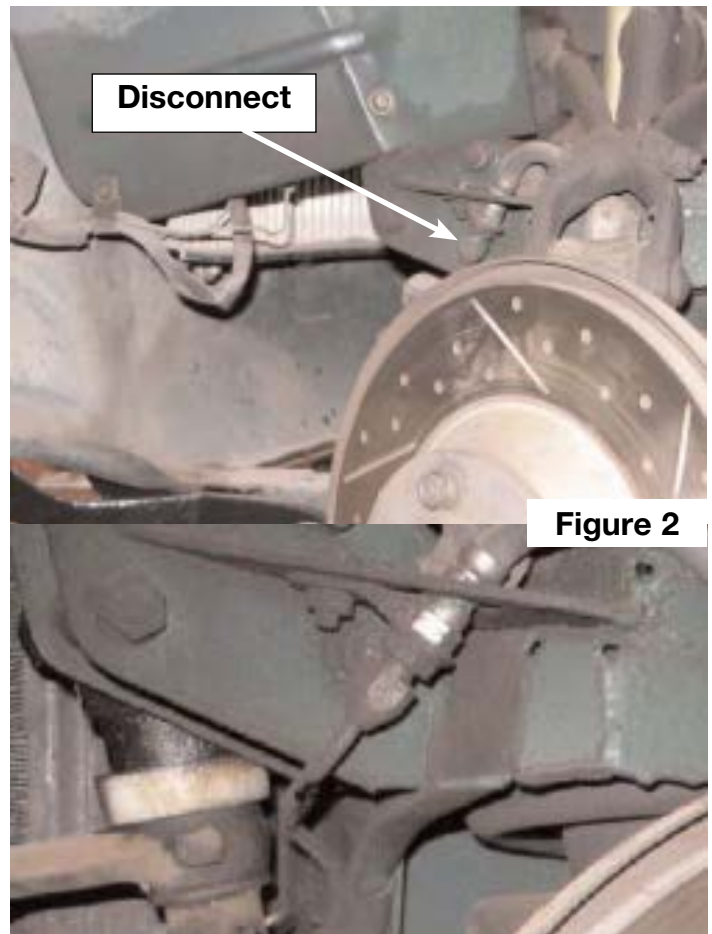
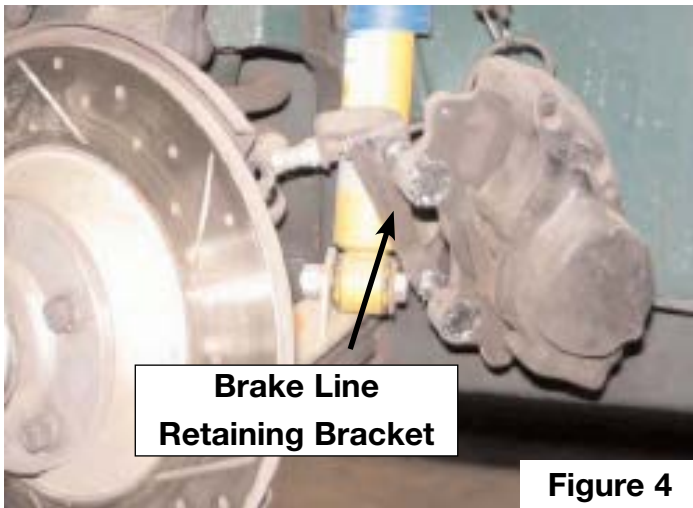

Figure 2

- 3) Remove the bolts that hold the heat shield to the brake caliper. However, do not remove those that also hold the caliper to the spindle.
- 4) Remove the two brake line bracket retaining nuts on the back side of the brake line bracket. This will allow the two brake caliper mounting bolts to turn. Refer to Figure 4.

Installation Instructions



- 5) Use a 3/4 inch combination wrench to loosen the two caliper mounting bolts. Remove the bottom bolt first. Then hold the caliper as you remove the upper bolt. Once the upper and lower bolts are free of the caliper and the splash shield mount, pull the caliper from the rotor and spindle mounts.
- 6) Use a Grease Cup Puller Tool (Moss # 384-935) and a slide hammer to remove the grease cup cover. Refer to Figure 6.

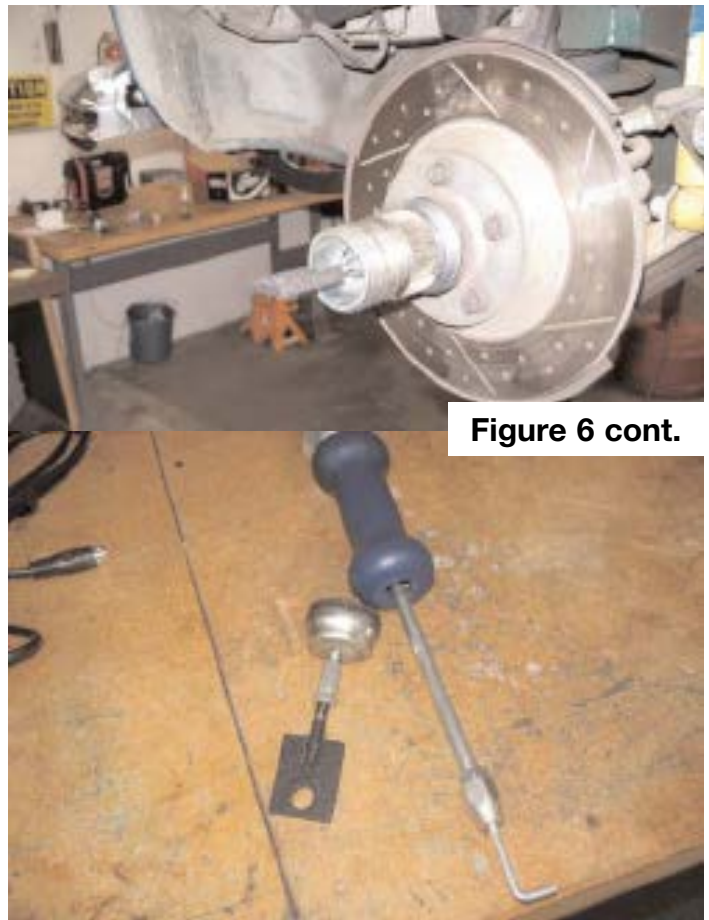
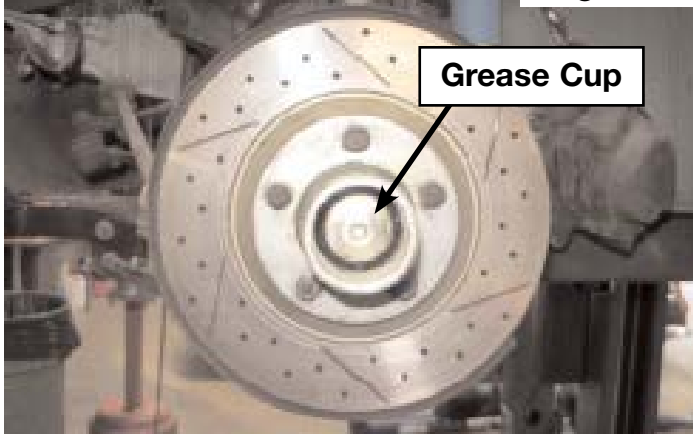

- 7) Spin the hub to get a feel for the drag of the wheel bearing assembly. Then use a pair of side-cutters to cut the cotter pin holding the spindle castle nut in place. Then use a 1-1/8 socket and ratchet to remove the castle nut. Refer to Figure 7



- 8) Remove the rotor/hub assembly as a unit. Save the castle nut, outer bearing, shims (there may be two), inner bearing and outer seal. Removal of the rotor/hub assembly may damage the seal if the inner bearing does not come off with the rotor/hub assembly. You may want to plan to already have replacements for the cotter pin (Moss # 325-440), seal (Moss # 535-055) and the inner (Moss # 126-000) and outer (Moss # 126-100) bearings. If you need them, the shims are 263-500 (.003"), 263-510 (.005"), 263-520 (.010") & 263-525 (.030"). Refer to Figure 8.



Figure 8



- 9) Use a 1/2" socket and ratchet to remove the two bolts holding the splash shield to the spindle. Save them for later reuse. Refer to Figure 9.

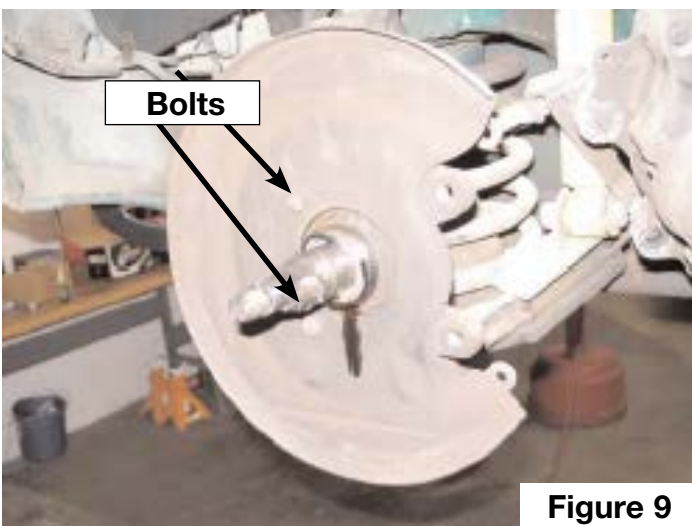

Figure 9

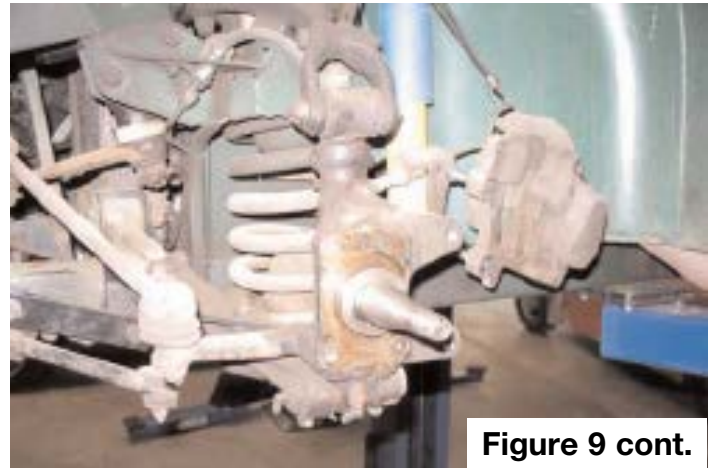

Figure 9 cont.

10. Use a 9/16 socket, ratchet and a 9/16 combination wrench to remove the five bolts, lockwashers and nuts securing the rotor to the hub. Then spray brake cleaner on the new rotors to clean them and to remove any rust inhibitor residue. Then place a new rotor onto the hub assembly. Secure it to the hub using the five mounting bolts, lockwashers and nuts removed previously. Torque the bolts to 35 ft-lbs in a cross pattern. Refer to Figure 10.



Figure 10

- 11) The backing plates (splash shields) can be reused, but they will only be mounted by the two bolts that attach them to the spindle. Alternatively, the car can be driven without the backing plates, but you will have to be careful on the first stop after running through a large puddle or in rain. If they are going to be reused, clean/scrape the grime and grease off of the backing plate. Then use the template on page 7 to cut the backing plate. Make sure to measure the template and verify the dimensions. If you find the template is the wrong size, you can print a new one from mossmotors.com. Place the template on the backing plate and mark the areas to cut with a marker. Your particular plate may require additional clearancing or slight bending to clear the rotor in all conditions, since only two mounting points will be used to secure it. File the edges smooth and use black paint on the freshly cut edges to inhibit rust.

Installation Instructions

- 12) If any bearings are to be replaced in the hub, pack them with grease and do so now. Then install a new inner bearing seal. Then remount the hub/rotor assembly onto the spindle. Install the shims, washer and castlenut. Use the procedure and torque described in the Service Manual to determine what shims and what torque to use. Install a new cotter pin and reinstall the grease cup. Refer to Figure 12.



Figure 12

- 13) Spin the hub to confirm proper drag. Adjust if necessary. Then reinstall the dust cap.
- 14) Gather a brake line retaining bracket from the kit. Refer to Figure 14.



Brake Line Retaining Bracket **Figure 14**

- 15) Mount the new caliper (bleeder screw goes up) onto the spindle using one provided washer on the lower bolt. Use one washer and the provided brake line retaining bracket on the upper bolt. It should be caliper, brake line retaining bracket, then the washer, then the bolt head. The calipers are tagged left and right. Rotate the brake line bracket so that it lies horizontally, pointing forward. Torque the mounting bolts to 60 ft-lbs with a 3/4 socket. Refer to Figure 15.

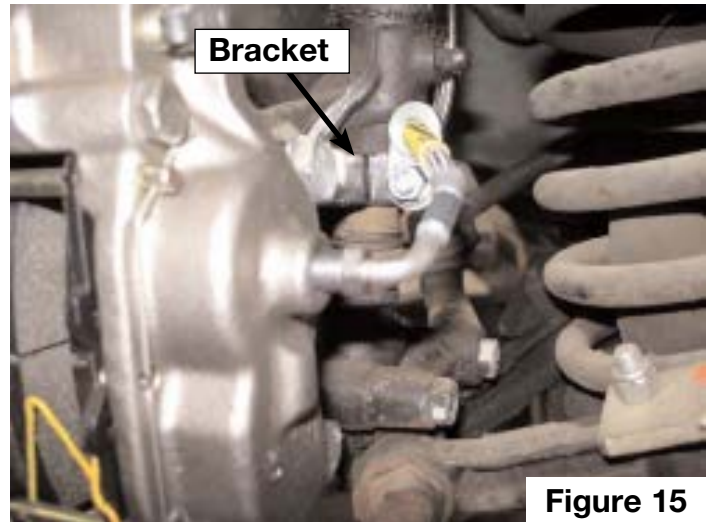

Figure 15

NOTE:

Brake line retaining bracket orientation as pointing straight forward from this picture of a later step.

- 16) Check for interference between the edges of the backing plate and the caliper. Minor clearance issues may be resolved by minor bending. Anything more will require additional cutting of the backing plate where it contacts the brake caliper.
- 17) Confirm that the hub/rotor assy spins freely with only minor drag from the bearings and the brake pads.
- 18) Locate the provided stainless steel braided brake lines. There are two front brake lines that are the same and one that is shorter for the rear of the car. Get one of the two provided front brake lines with the 90 degree elbow at the end. Use 1/2 and 11/16 open end wrenches to attach the straight end of the new brake line to the brake hard line connection and brake line bracket at the body. Include the lockwasher from the original brake line. The line should rest next to the suspension mount and clear the pad for the bump stop. You may want to move the brake fluid stopper to the end of the new brake line to keep the fluid from draining again while you work. Refer to Figure 18.



Figure 18

19) Run the brake line downwards and then rearward towards the caliper. Hand thread the fitting at the end of the 90 degree elbow into the caliper. There is a line locator on the new brake line. It is lightly crimped and can be moved. Adjust the line locator so that it can be positioned just beyond the end of the brake line retaining bracket with the brake line running above it. Insert a provided bolt and thread on a lockwasher and nut through the hole in the line locator and the brake line retaining bracket. Refer to Figure 19.



Figure 19



Figure 20

20) Recheck that the line locator is positioned with enough slack in the brake line not to be under heavy tension and tighten the line locator nut and bolt. Turn the wheels lock to lock to check. Make sure that the line locator is rotated as far upward and toward the spindle as possible for best clearance to the spring. Then use a 10mm combination (or a flare nut) wrench to tighten the brake line fitting at the brake caliper. Refer to Figure 20.

21) Turn the brake rotor and check for interference between the pad anti-squeak spring and the rotor. Adjust if necessary with a pair of needle-nosed pliers. Refer to Figure 21.



Figure 21

NOTE:

The tip of the "V" shaped pad spring should point in the direction of wheel rotation when the car is going forward. If the spring does not point in that direction, remove and reinstall it.

22) **Repeat Steps 2 through 21 for the right side of the vehicle.**

Installation Instructions

- 23) Install the provided braided stainless steel rear brake line from the kit. Refer to Figure 23.



Figure 23

- 25) Bleed the brakes. When the calipers and brake lines are full of fluid, tap the calipers with a rubber mallet to knock any trapped air bubbles loose. Then bleed those bubbles out.
- 26) Check for leaks. Test the brakes on a low traffic road to assure that they have been successfully bled. Return to your garage and recheck for leaks. Then, and only then, bed the brake pads. Bed the brake pads by stop- ping aggressively from 60mph to 10mph (DO NOT COMPLETELY STOP) five times. Cruise at 60mph for a minute between every two runs.
- 27) Enjoy your new four piston brakes and stainless steel lines! Please see MossMotors.com for all of your Triumph Performance and Accessory needs.

Although every effort has been made to ensure the accuracy and clarity of this information, any suggestions that you may have that will improve the information (especially detailed installation notes and photos) are welcome. These instructions were developed and written by Moss Technical Support. If you have any questions or difficulties with your installation of this product, telephone 800-667-7872 between 7:00 a.m. and 4:00 p.m., Pacific Time for assistance.

Moss Motors, Ltd.
440 Rutherford Street, Goleta, California 93117
In the US & Canada Toll Free (800) 667-7872
LOCAL (805) 681-3400 FAX (805) 692-2510



Moss Europe Ltd.
Hampton Farm Industrial Estate
Hampton Road West, Hanworth Middlesex, TW13 6DB
In the UK: 020-8867-2020 FAX:- 020-8867-2030

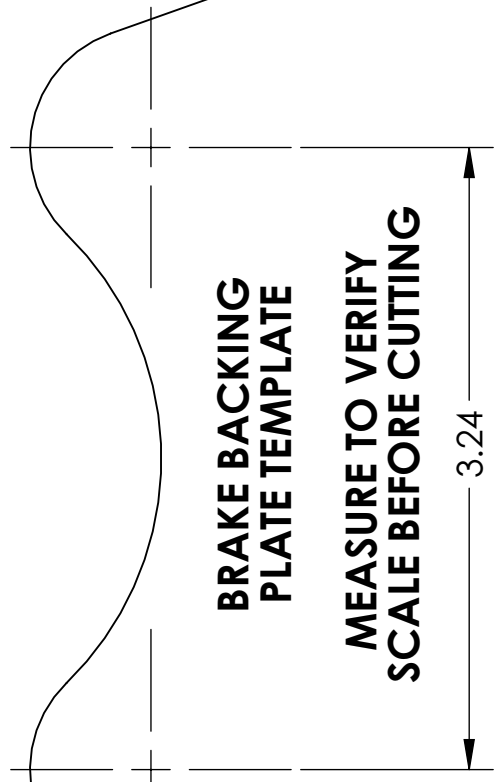
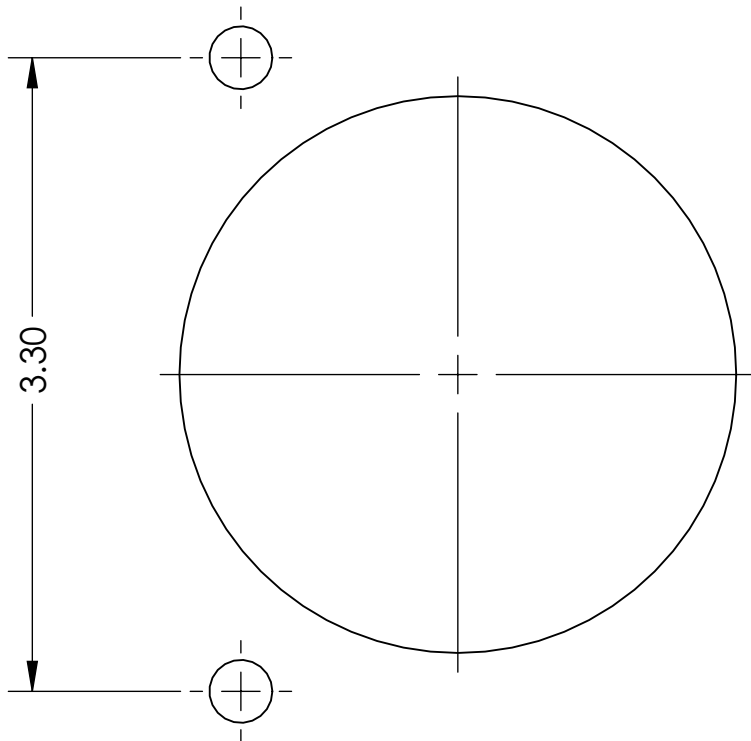

**BRAKE BACKING
PLATE TEMPLATE**
**MEASURE TO VERIFY
SCALE BEFORE CUTTING**

