



Spridget Supercharger System

Installation Instructions

FOR All Spridgets with factory 1275cc motors

PART # 150-088

440 Rutherford St. P.O. Box 847 Goleta, CA 93117
1-800-667-7872 • FAX 805-692-2525 • www.mossmotors.com

Please read and understand these instructions completely before you begin the installation.

A few notes before you begin:

Emissions Equipment – This supercharger system may not be legal in your state.

Installation – The mechanical installation of a supercharger system is a relatively simple bolt-on affair. However, tuning a supercharged engine for maximum performance and engine life requires a high level of skill and understanding of engine systems. Achieving the proper balance of air/fuel ratio, boost and timing could require considerable effort. The kit has been engineered for a stock engine and should provide a reasonable state of tune with good performance. Your results will definitely be different and may require further tuning.

Engine condition – This system is designed to supplement an engine in good condition, not to make up for lost power in a tired one. If your car has a tired engine you should overhaul it before installing a supercharger system. Your engine should have fresh tune up, including new spark plugs wires, points, condenser, distributor cap and rotor. NGK BPR7ES (2023) spark plugs, #052-504, are included with the system, gap 0.035in. Be aware that when replacing plugs, cross-referenced plugs may NOT have the same heat ranges, “hotter” plugs could lead to detonation and engine damage.

A good mechanical background or experienced professional is needed to install this kit.

Hose clamps - Re-use hose clamps, or purchase new ones where necessary. Use new hose clamps on all fuel connections.

Carburetor – The supplied SU HIF 44 carburetor has been pre-tuned and jetted for a supercharged Spridget with a stock engine. The metering rod, jet, and slide have been altered to run properly and safely on a wide range of supercharged, unmodified engines. We cannot be responsible for modified engines – we recommend dyno tuning modified engines, while reading the air fuel ratio, to avoid any running in lean conditions. The carburetor has a BCA needle, a 4.5oz spring, and uses Marvel Mystery brand air tool oil in the dash-pot.

Fuel Requirements - *You must run premium fuel (91 octane or better) in your supercharged Spridget.*

Distributor – We recommend running either a stock distributor or a Moss #143-115 distributor. The 143-115 is preferred because it provides an excellent advance curve.

How superchargers work – Superchargers compress the air/fuel mixture, filling cylinders with a greater charge than when normally aspirated. Normally aspirated engines produce vacuum, read in inches of mercury, superchargers and turbochargers produce boost, read in positive pounds per square inch.

Boost capacity is determined by supercharger RPM which is, of course, affected by pulley size (the smaller the supercharger pulley, the faster

Installation Instructions

the supercharger turns at the same engine speed). Actual boost is determined by atmospheric pressure (a combination of altitude, temperature & humidity) and internal engine back pressure which is governed by engine design, intake/exhaust valve overlap and engine compression.

Assuming that the car has a stock camshaft and the engine is in good shape, you may expect 6 to 7 lbs. of boost with the Moss supercharger system utilizing the supplied 3.1in pulley.

Raising your compression ratio one point (8:1 to 9:1) is equivalent to adding two psi of boost. Therefore a higher compression engine with less boost will make similar power to a low compression engine with more boost, all else being equal.

Higher boost in a higher compression engine will often lead to detonation and engine damage. The most common mistake in supercharger tuning is trying to run too much boost or too much advanced timing.

Our dyno sheets were produced with a stock distributor, the same carburetor tuning as supplied in this system, and 9° of initial timing, on a 1973 MG Midget with a stock engine and 8.8:1 compression, at sea level using a Mustang chassis dynamometer – ***your results will definitely vary.***

Supercharger Accessories:

Boost Gauge Kit– period correct face, #150-028

NGK 2023 BPR7ES Spark Plugs, #052-506

K&N Air Filter Cleaning Kit, #001-130

SU HIF-44 Carb Rebuild Kit, #375-628

4-Rib Serpentine Drive Belt(Gates K040595), #052-234

Tools required:

Sockets: Standard – 7/16in, 1/2in, 9/16in, 7/8in (or 22MM), 1-5/16in, 13/16in spark plug. Metric – 12, 18, 22 (or 7/8IN).

Drives: two 3/8in drive ratchets. 1/2in drive torque wrench. A 1/2in impact wrench and 3/8in air ratchet will make installation easier.

Combination Wrenches: Standard -- 9/32, 5/16, 11/32, 3/8, 7/16, 1/2, 9/16, and 5/8in combination wrenches. 3/8, 7/16, 1/2, 9/16 ratcheting wrench will make installation easier. Metric – 10mm, 12mm,

Allen wrenches: 7/32in

Other tools: 3" and 6" extensions for a 3/8 drive ratchet. 1/2in drive breaker bar. A feeler gauge or spark plug gap gauge. Medium and small flat blade screw drivers, Medium Phillips screw driver, 90° Phillips screw driver, chisel, hammer, deadblow hammer, round file, hacksaw, floor jack and wood block, gasket scraper, BrakeKleen and rags, coolant and catch pan, and a bottle of anti-seize. A timing light – we recommend a timing light with an adjuster wheel so that you can set your timing more accurately.

Disclaimer: Moss Motor, Ltd. is not liable for injury or damage due to incorrect installation or misuse of their products. All products are sold with the understanding that safe and proper installation and use of any product is the end user's responsibility.

Installation

1. Disconnect the battery ground cable. Block your wheels.
2. Drain coolant; please dispose of properly if you are not re-using it. Disconnect the lower radiator hose from the radiator.
3. Using a 1/2in socket, remove air cleaners.
4. Once the air cleaners are removed, you can disconnect the choke and throttle cables. See Illustration 1



Illustration 1



Installation Instructions

5. Disconnect the fuel feed hose from the main fuel line at the front of the engine. Remove the excess line and filter from the carburetor and drain the excess gasoline. It may help to pinch the fuel line before removing so that gas is not spilled. See Illustration 2

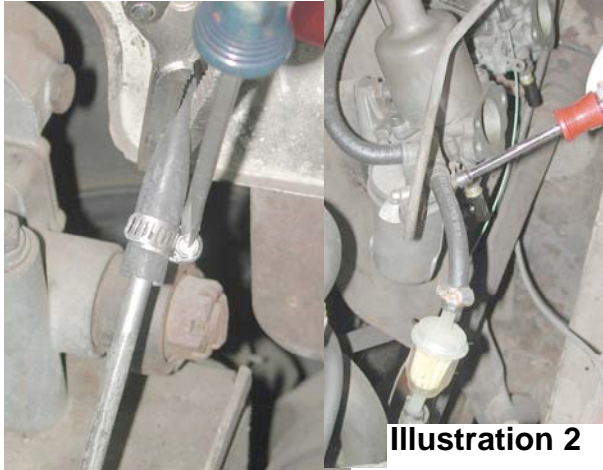

Illustration 2

6. If applicable, disconnect bowl vent line assembly from both carburetors and at the charcoal canister (if fitted). Disconnect the timing cover vent hose at the timing cover oil separator. Disconnect the vacuum lines to and from the carburetors and/or manifold. Disconnect the vacuum advance line from the manifold and from the distributor. See Illustration 3

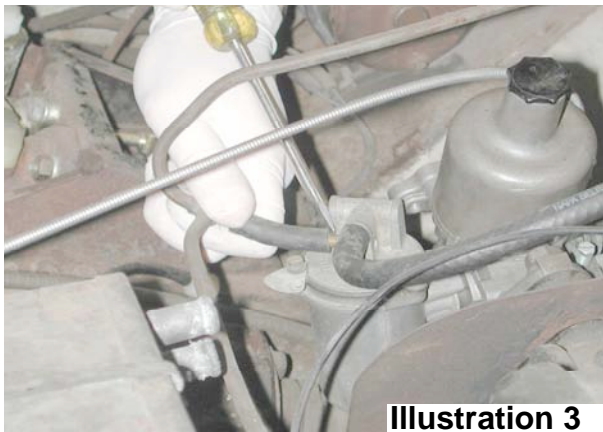
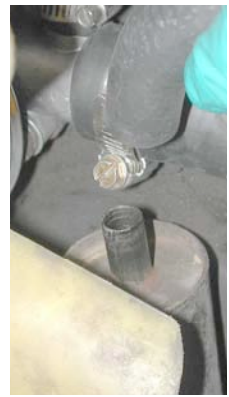

Illustration 3



7. Using a 9/16in wrench, remove the nuts securing the carburetors to the manifold. Then remove the carburetors. We found it easier to remove the carburetors before removing the intake manifold. However, it is possible to remove them as a unit. See Illustration 4

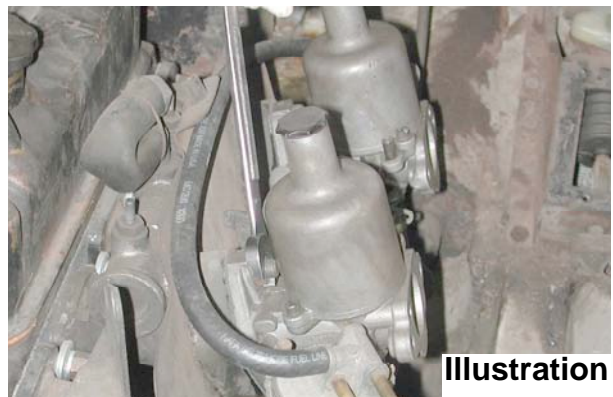

Illustration 4

Installation Instructions

8. If applicable, remove the “gulp” valve using a 7/16in socket and wrench. This is the valve located above the forward carburetor, connected to the smog pump (air pump). Disconnect the vacuum source from the intake manifold. Disconnect the large hose from the intake manifold. The gulp valve will not be used. See Illustration 5



Illustration 5

9. If applicable, remove the bolt securing the heat shield support bracket at the front engine plate with a 7/16in combination wrench and slide the heat shield off of the studs along with the carburetor spacers.

10. Using a 1/2in socket, remove the nuts securing the intake and exhaust manifold. Then remove the intake manifold. Disconnect the exhaust support bracket at the transmission bellhousing. Pull the exhaust manifold away and remove the manifold gasket. Clean the manifold gasket surface. A new intake/exhaust manifold gasket is included in your supercharger system that will be installed later. You will reuse the manifold fasteners. If fitted, the gulp valve mounting bracket will have to come off first. Also, this is a good time to replace your studs if they are corroded or worn.

11. The grill will need to be taken off for the removal of the radiator. The grill is retained by 6 six screws and requires a medium Phillips head screw driver for removal. See Illustration 6

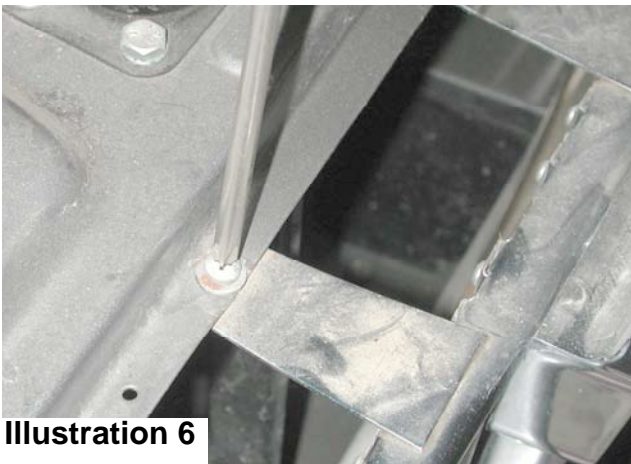

Illustration 6

150-088

12. Remove upper radiator hose and coolant reservoir hose(if fitted). Remove the radiator using a 7/16 socket or wrench and medium flat blade screw driver. The 4 fasteners requiring the 7/16 socket can be reached from inside the fender well. See Illustration 7

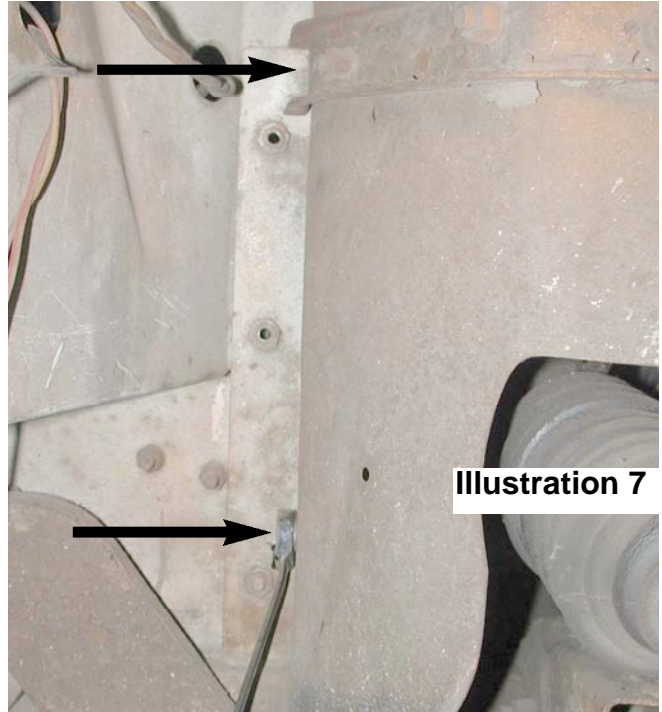

Illustration 7

Now, remove the 4 screws that secure the radiator shroud at the top and bottom using a medium flat blade screw driver. See Illustration 8 Once the fasteners are removed the radiator can be lifted out from the top. Try to minimize contact between the radiator fins and the fan during removal.



Illustration 8

13. Completely remove the lower radiator hose assembly and the hard line that goes to the heater. If a cross flow tube is fitted a 1/2in socket will be required to remove it. See Illustration 9

Installation Instructions

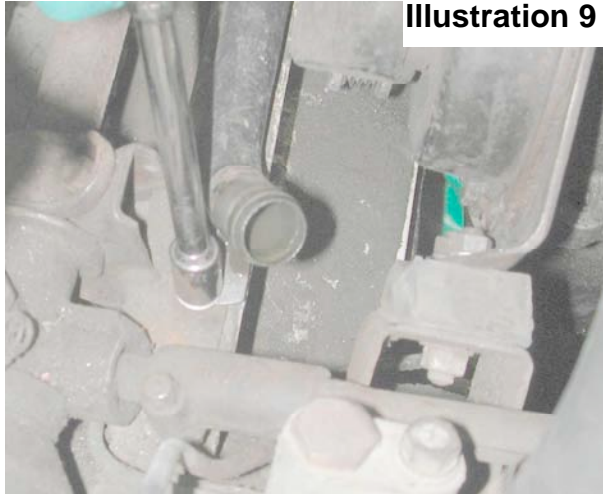

Illustration 9

14. If applicable, remove the hose clamp and hose that leads to the air injection rail. See Illustration 10

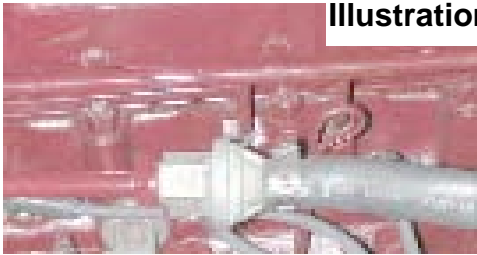

Illustration 10

15. Loosen the smog pump adjustment link and remove the belt. Remove the adjustment hardware and slide for the smog pump(2). Loosen and remove the pivot bolt(1) and remove the smog pump. The smog pump will not be re-installed. See Illustration 11

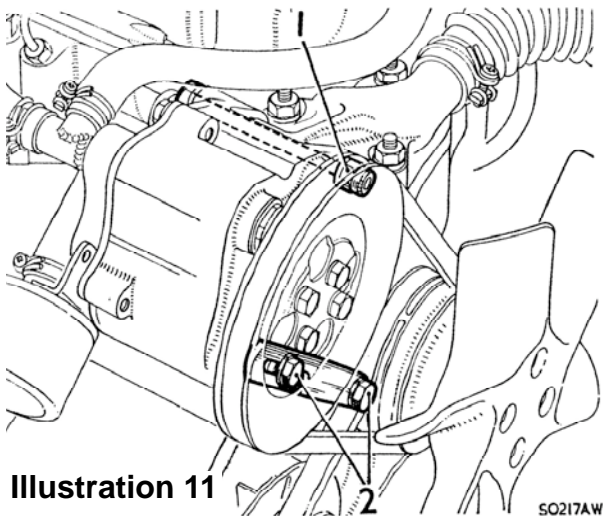

Illustration 11

16. At this time, using a 7/16in socket, just loosen the four bolts which hold the fan to the water pump.

17. Loosen the main drive belt that drives the water pump and generator/alternator by loosening the adjustment link and pivot hardware with a 1/2in wrench, 9/16in socket and 1/2in socket. Remove the belt. Remove the adjustment link(1 and 2). You will reuse the pillar block nut, washer and lock washer used to fix the adjustment link. Remove the two generator/alternator pivot bolts using a 1/2in socket and wrench(1). Unplug the generator or alternator and remove it from the vehicle. See Illustration 12A or 12B

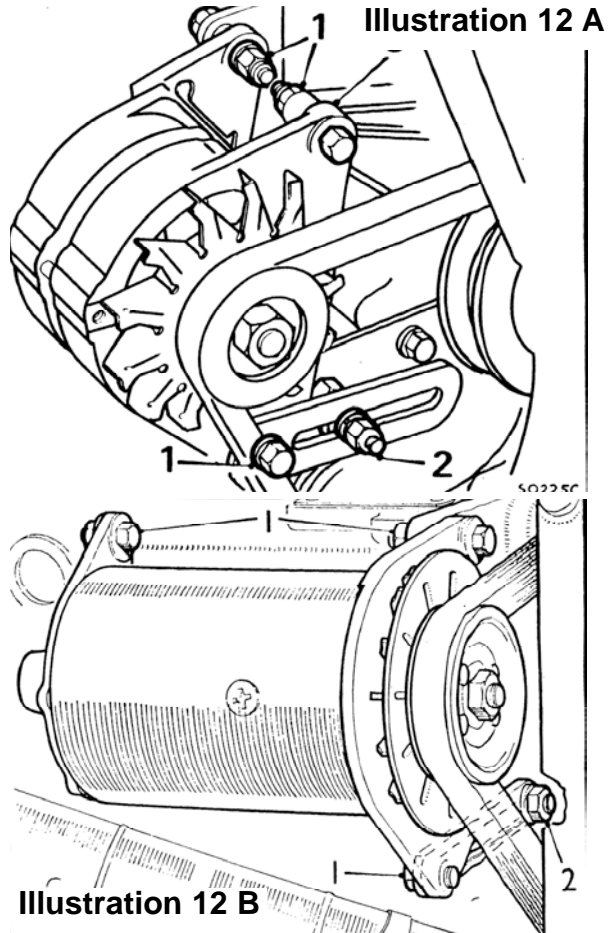

Illustration 12 B

18. Loosen the 7/8in or 22mm (this could be different for your car, use the appropriate socket) nut in the center of the generator or alternator. You will need to stop the fan from turning, a carefully positioned rag can help. We recommend using an impact gun for loosening this nut. Replace the pulley with the 4-rib pulley supplied in the kit. During installation, the woodruff key has a tendency to slide out of it's groove. To prevent this, hold the woodruff key in place with a small screw driver. See Illustration 13

Installation Instructions

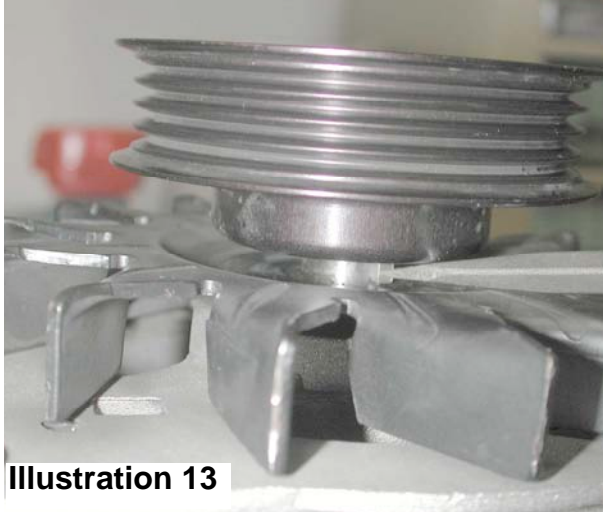

Illustration 13

It is okay to lightly tap the pulley onto the shaft with a dead-blow hammer or a wood block until it is seated against the fan. If installing on a generator a new fan has been supplied. Tightening the new pulley will be the reverse of the removal of the old one using an impact gun. The assembly is tight when the fan doesn't move and when the lock washer is crushed. See Illustration 14

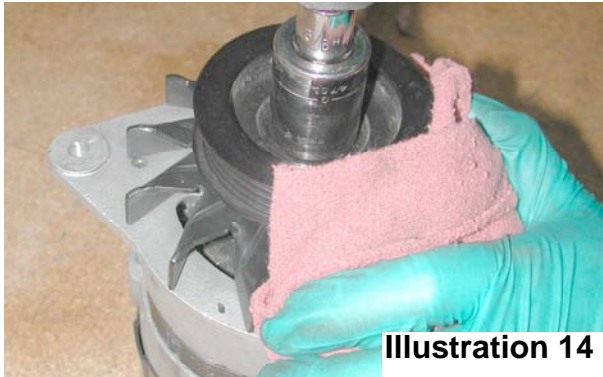

Illustration 14

19. Remove the water pump pulley and fan by removing the four bolts that were loosened in step 16. Using a 1/2in socket, remove the water pump and bypass hose. You may need a catch pan for additional coolant. Scrape the gasket surface in preparation for the new water pump. Install the new water pump and bypass hose supplied in the kit using the same hardware. If applicable, the smog pump adjuster bracket(if fitted) will not be reinstalled.

20. The crank pulley will be replaced with a 4-rib serpentine pulley. To do this place a wooden block on a jack and raise the wood to just touch the oil pan on the engine. Now using a 1/2in socket with a 6in extension remove the bolts that secure the engine mounting brackets to the vehicle. See Illustration 15



Illustration 15

Remove the nuts that secure the rubber engine mounts to the front of the engine using a 1/2in wrench. See Illustration 16.



Illustration 16

Elevate the motor with the jack slowly and remove the motor mounts at the same time. It might help to remove the passenger side motor mount first so that the engine can be rocked toward the passenger side of the vehicle to remove the drivers side motor mount. New rubber motor mounts have been supplied and should be replaced at this time.

21. The motor should be elevated so that the crank pulley can clear the cross member. Bend the ear on the lock tab washer back with a hammer and chisel. See Illustration 17



Illustration 17 A

Installation Instructions



Put the car in gear and set the e-brake or get a friend to engage the brakes firmly. Now remove the crank pulley bolt with a 1-5/16in socket and 1/2in drive breaker bar or impact gun. See Illustration 18

Illustration 18



Remove the pulley, using the appropriate puller if necessary, and replace it with the new one supplied in the kit. A little anti-seize on the crank may ease installation. If necessary, tap on the new crank pulley with a dead-blow hammer or wood block. See Illustration 19



Install a new tab washer with the concave side facing the crank pulley bolt head. Reinsert the crank pulley bolt and tighten to 70 lb-ft(9.6kg-m) using a torque wrench. You may want to also use anti-seize on the crank pulley bolt. See Illustration 20



There is a depression in the crank pulley face. Bend the tab washer into this depression using a hammer and chisel. Use a medium flat blade screw driver to bend an ear up to one of the flats on the hex head on the crank pulley bolt. See Illustration 21



Installation Instructions

22. While lowering the engine, re-install the engine mounts. Install the driver's side loosely and then the passenger side. See Illustration 22



Illustration 22



Do not forget to reattach the ground strap. This would be a good time to ensure that the ground strap has a good contact surface. See Illustration 23.



Illustration 23

You may want to keep the jack under the engine just in case you have to use it to aid in alignment of the motor mount securing bolts.

23. Remove the air injection tubes. We highly recommend that you use a 7/16in tubing wrench (flare nut wrench) to break them loose! Then a

standard open end wrench may be used once they are loose. However a standard open wrench is not recommended for breaking the nuts loose, they can very easily damage the heads. Be patient, these seem to have very long threads. See Illustration 24



Illustration 24



You will then insert the four 7/16-20 by 1/2in set screw plugs into the air injection tube holes. We recommend putting anti-seize on the plugs. Use a 7/32in Allen wrench, tighten snugly. See Illustration 25

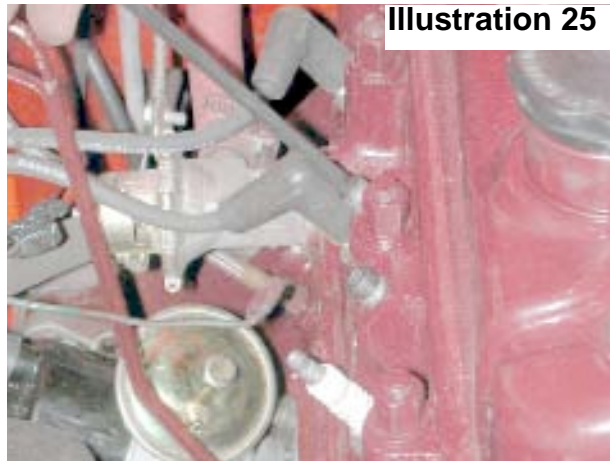

Illustration 25

24. Find the idler plate provided in the kit. See Illustration 26

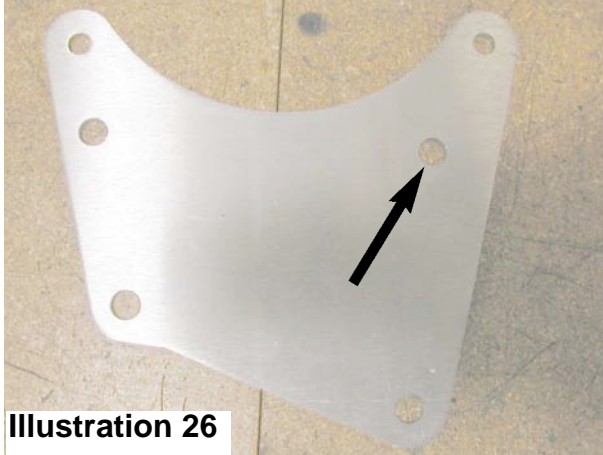

Illustration 26

Find the Nylon idler pulley, a 3/8-16 x 2.25in bolt, two 3/8in washers, a tapered spacer and a 3/8-16 nyloc nut provided in the kit. See Illustration 27



Illustration 27

Install these components on the idler plate as shown. From front to back the bolt should go through the first washer, pulley, second washer, tapered spacer, idler plate, and the finally the nyloc nut. Tighten the assembly using a 9/16in socket and wrench. See Illustration 28

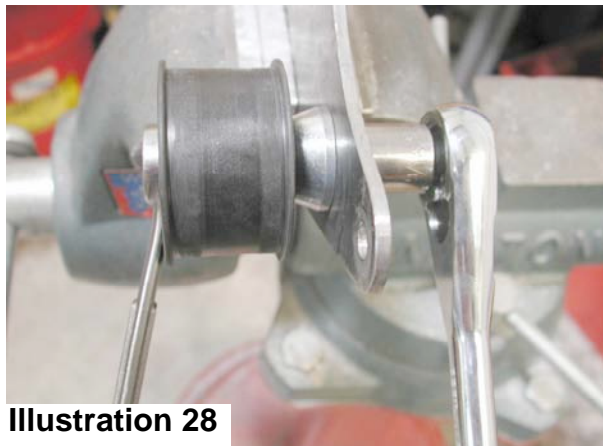

Illustration 28

25. Find the dynamic tensioner and assemble it to the idler plate with two 3/8-16 x 1in bolts, two 3/8 washers and two 3/8-16 nyloc nuts. Tighten using a 9/16in socket and wrench. See Illustration 29

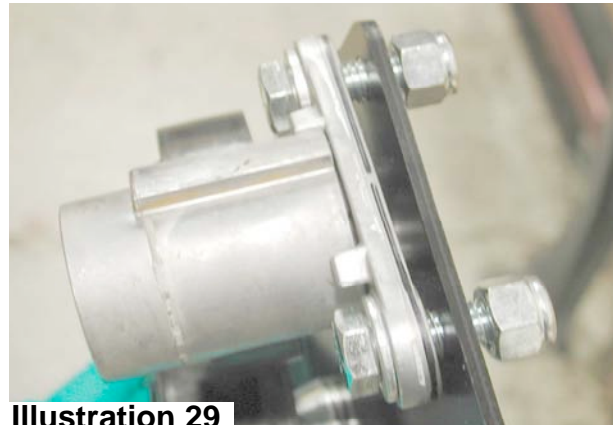

Illustration 29



26. For cars running a generator, a short, flat bracket has been provided that will need to be installed on the idler plate. If running an alternator, move on to the next step. Find this bracket and attach it to the idler plate using a 5/16-18 x .75in bolt, lock washer and 5/16-18 nut. Leave the assembly finger tight for now. See Illustration 30

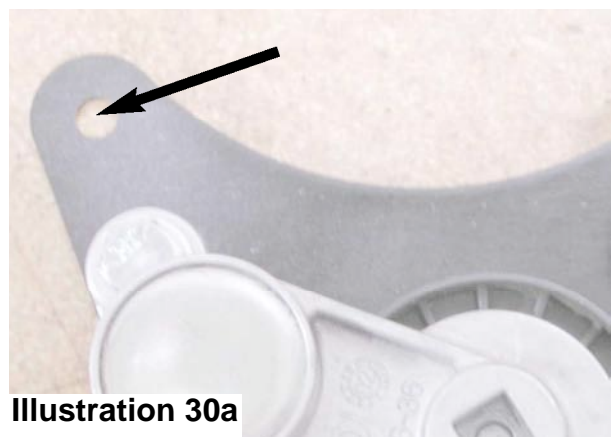
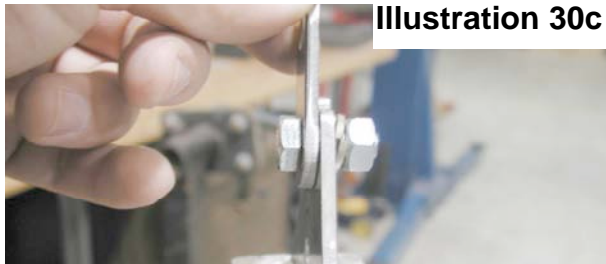
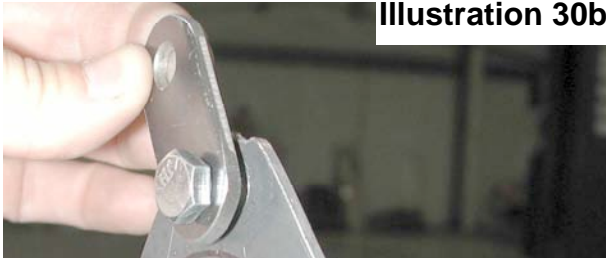
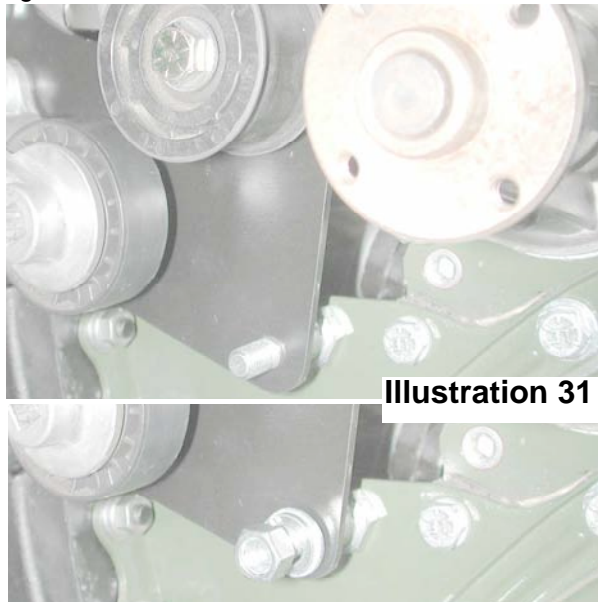

Illustration 30a

Installation Instructions



27. Refit the alternator or generator by first attaching the rear mounting ear to the rear mounting bracket on the engine block. Install the idler plate assembly by first locating on the pillar block stud (mounted on the engine plate) with the lower hole of the plate. Return the washer, lock washer and pillar block nut (alternator/generator adjustment nut) to the pillar block stud, leave finger tight. See Illustration 31



28. If running a generator move on to the next step. Find a 5/16-24 x 1.75 bolt and two 5/16 washers. Insert the bolt through top hole on the idler plate, the 5/16 washer, the front mounting ear on the alternator and then the mounting ear on the water pump. See Illustration 32



Use the original nut and washers on this new bolt and leave finger tight. Now insert the adjustment link bolt and lock washer through the last hole in the idler plate, a 5/16 washer and then thread into mounting ear of the alternator. An M8 x 1.25mm x 25mm bolt and a 5/16-18 x 1.00in bolt have been provided in case your adjustment link bolt is not long enough. A new 5/16 lock washer has also been provided. See Illustration 33

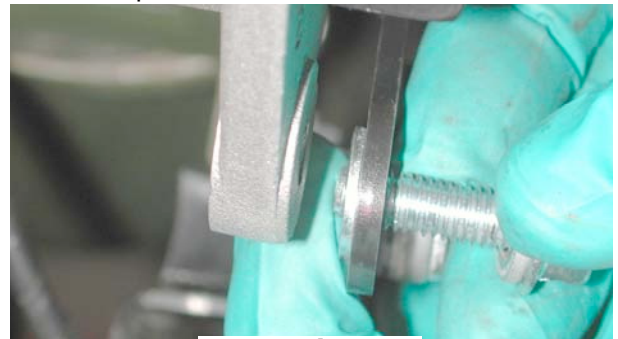

Tighten the 5/16-24 x 1.75 bolt first using a 1/2in wrench and socket. Now, tighten the adjustment link bolt and then the rear mounting bolt. It may help to loosen the rear mounting bracket from the engine block and then tighten it last during this procedure. Reconnect the wires to the back of the alternator. The 5/16 washers are used as shims to space the alternator for proper belt alignment. Because of production variations in the alternators and mounting hardware some cars may require a different arrangement of shims to achieve proper belt alignment. The above recommendations are good starting point, but may not suit your car. Extra washers have been provided in case more shimming is needed. On our test car we only needed two 5/16 washers total to correctly space the alternator. 4 washers in all have been provided for this procedure. Checking proper belt alignment will be addressed later.

29. If running an alternator move on to the next step. Find a 5/16-24 x 1.75in bolt and two 5/16 washers. Insert the bolt through top hole on the idler plate, the front mounting ear on the generator, a 5/16 washer, and then the mounting ear on the water pump. See Illustration 34

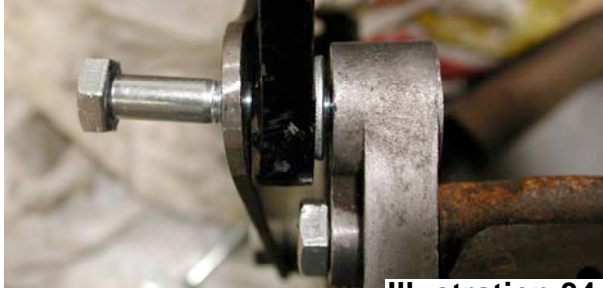

Illustration 34



Use the original nut and washers on this new bolt and leave finger tight. Now insert the original adjustment link bolt with lock washer through the short, flat bracket on the idler plate, two 5/16 washers and then thread it into the mounting ear. A 5/16-18 x 1.00in bolt has been provided in case your adjustment link bolt is not long enough. A new 5/16 lock washer has also been provided. See Illustration 35

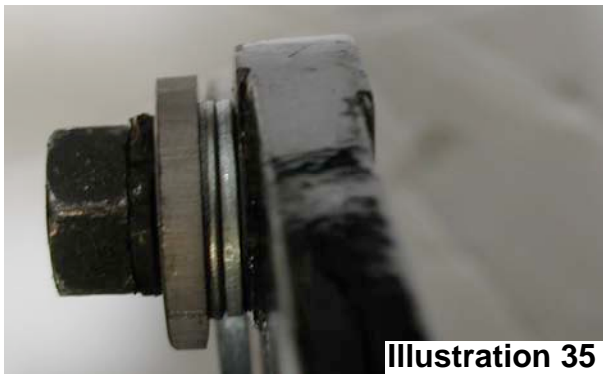

Illustration 35

Tighten the 5/16-24 x 1.75 bolt first using a 1/2in wrench and socket. Now, tighten the adjustment link bolt and then the rear mounting bolt. It may help to loosen the rear mounting bracket from the engine block and then tighten it last during this procedure. Reconnect the wires to the back of the generator. The 5/16 washers are used as shims to

space the generator for proper belt alignment. Because of production variations in the generators and mounting hardware some cars may require a different arrangement of shims to achieve proper belt alignment. The above recommendations are a good starting point, but may not suit your car. Extra washers have been provided in case more shimming is needed. On our test car we only needed one 5/16 washer for the generator adjustment link bolt (instead of two) and one for 5/16-24 x 1.75 bolt to correctly space the generator. 4 washers in all have been provided for this procedure. Checking proper belt alignment will be addressed later.

30. If the vehicle does not utilize a cross-flow radiator then move on to the next step. Temporarily refit the metal cross tube that mounts to the front cross member and attach the short coolant hose elbow. Now move the dynamic tensioner with a 3/8in drive ratchet. **Notice that tensioner pulley gets very close to the hose and may even make contact.** To overcome this potential interference the mounting holes on the cross tube must be slotted so that the assembly can be moved away from the tensioner. The mounting hole on the passenger side of the cross tube must be slotted inward. See Illustration 36



Illustration 36

The mounting hole on the drivers side will be slotted outward and will be break through the end of the bracket. See Illustration 37



Illustration 37

Installation Instructions

These modifications will require the use of a hack saw and round file. Remove the short coolant hose elbow before modifying. A cut-off wheel, rotary file and pneumatic grinder will make this job easier. See Illustration 38



Illustration 38



Clean any burrs and then install the modified cross tube and short coolant hose elbow on the front cross member using the 1/2in wrench and socket. Make sure that the tube is adjusted to avoid interference with the dynamic tensioner. Install the short hose elbow and hose clamp using a medium flat blade screw driver, but leave the hose clamp loose so that it can be adjusted when reinstalling the radiator. Check the clearance again. If the dynamic tensioner pulley still comes in contact with the hose more modification is needed. Try the filing the slot so that the cross-tube can be moved forward (toward the front of the car). See Illustration 39



Illustration 39

31. Find the 4-rib water pump pulley and install it on the water pump along with the fan, original mounting bolts and new 1/4 lock washers(provided) using a 7/16in socket. Four 1/4-28 x .75in replacement bolts have been provided for vehi-

cles running a metal fan. Tighten to 9 ft-lb. Snug in a cross pattern. Spin the fan to make sure everything is OK. See Illustration 40



Illustration 40



32. Now to the supercharger assembly. The supercharger, manifold and carburetor come pre-assembled.

33. Fill the carburetor dashpot with oil. Orient the supercharger assembly so that the carburetor is level. The carburetor is shipped dry and should be filled with the included dashpot oil. Unscrew the black dashpot cap, and pull it up to remove the damper. Set it aside. Now fill the center shaft to about 3/4in from the top, with the supplied oil (you may want to use side-cutters to increase the opening in the bottle nozzle). Reinstall the damper and screw on the dashpot cap. Although oil weight can be change for tuning, we highly recommend using the included dashpot oil unless you are very familiar with SU carburetors, and have a dynamometer and wide-band O2 sensor available for tuning. See Illustration 41

Illustration 41



34. The A-series head utilizes two rings for locating the intake manifold ports to the head. These rings come seated in the stock intake manifold, but will have to be installed in the supercharger manifold. Find the locating rings that have been provided and press them into end of the intake manifold runners. It may help to tap them lightly with a hammer, but do not force them in. There is a possibility that very small aluminum chips may result from the rings sliding down into the recess. We suggest stuffing a rag down into the runners to catch any chips that may result. Make sure to take the rag out when finished. See Illustration 42

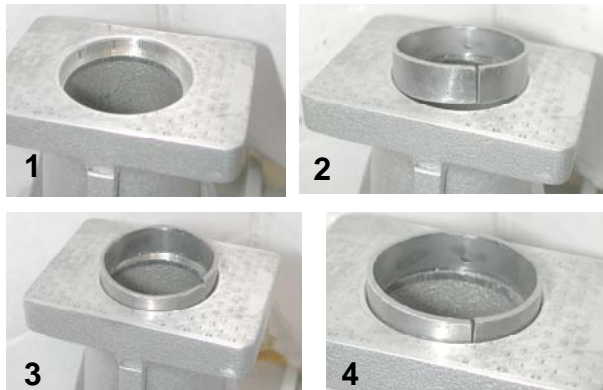

35. Install the supercharger assembly. Install the new intake/exhaust manifold gasket. Determine if the flange thickness of the exhaust manifold and new intake manifold are the same. If they are different, measure, as accurately as possible, the thickness of the exhaust manifold flange, and your new intake manifold flange. Use the supplied shims to achieve the proper thickness. The supplied adhesive can be used to hold multiple shims together and also hold the shims to the washers to aid in assembly. Once your shims are in-place, hang the blower. Hold the assembly and carefully position the locating rings in the recesses of the intake ports on the head. There are two timing cover bolts that may interfere with the blower nose support bracket (attached to the supercharger assembly) if they stick out of the back of the front engine mounting plate. Back these bolts out while mating the manifold to the head if this interference condition exists. Install two nuts and washers to hold the blower assembly in place. Slip on the rest of the big washers, lock washers, and start the nuts. Tighten the manifold fasteners from the center ones to the outer ones; torque them to 20 ft-lb. Note: The intake manifold mounting pads are shaped like a rectangle and are larger, in some regards, than the mounting pads on the stock intake manifolds. We made an effort to

ensure that this larger pad will work with the stock exhaust manifold and some aftermarket headers. If you are having trouble fitting the manifold it may be interfering with a header flange. In this case you will have to modify your header flange. See Illustration 43



Illustration 43

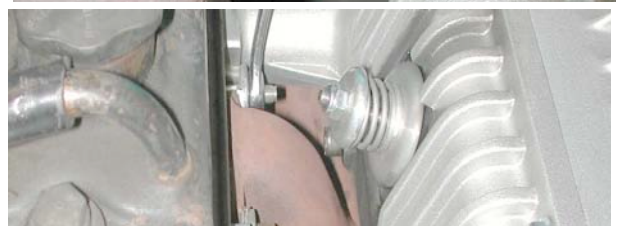
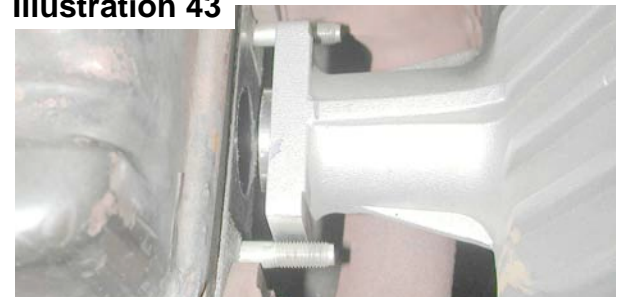

36. Remove the timing cover bolt closest to the drivers side engine mount and the bolt just above it using a 7/16in socket. Replace these bolts, using the original washers underneath the heads, with the two 1/4-28 x 1in bolts provided. These bolts should pass through the engine plate and into the lower holes on the supercharger support bracket. Use the two 1/4-28 nuts and 1/4 lock washers to tighten the bracket against the back-side of the engine plate. See Illustration 44

Installation Instructions

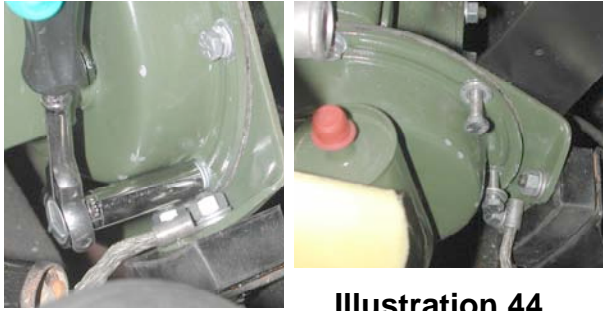

Illustration 44



37. Find the rear supercharger support bracket, a 5/16 washer and a 5/16-18 x 2in bolt. Assemble the bolt and washer to the hole on the tab at the bottom of the bracket. Install the bracket on the engine by locating the bolt to a hole on the lower part of the engine casting at the rear. Illustration 45

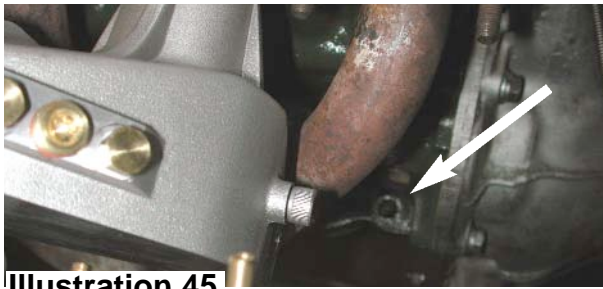
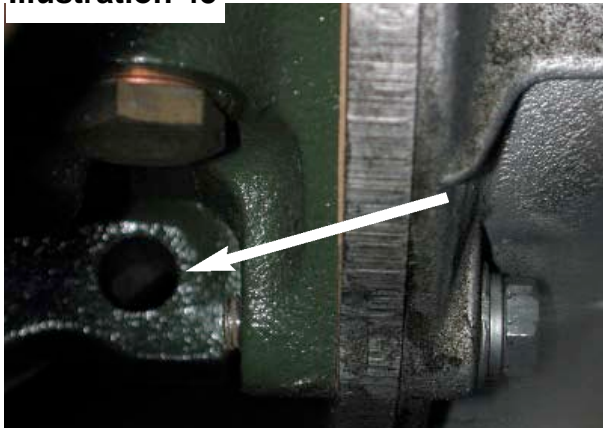

Illustration 45



Feed the bolt through this hole. See Illustration 46

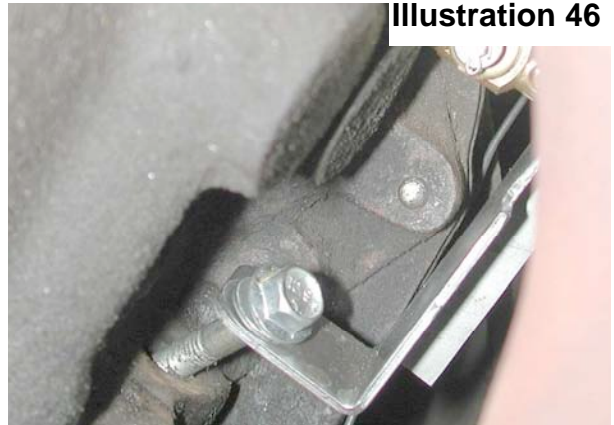

Illustration 46

Find a 5/16-18 x 1in bolt, a 5/16 lock washer and the 5/16 fender washer supplied in the kit. Fit the bolt, with washers, through the slot of the rear support bracket and thread it into the lower hole in the supercharger manifold. Leave this bolt loose. See Illustration 47

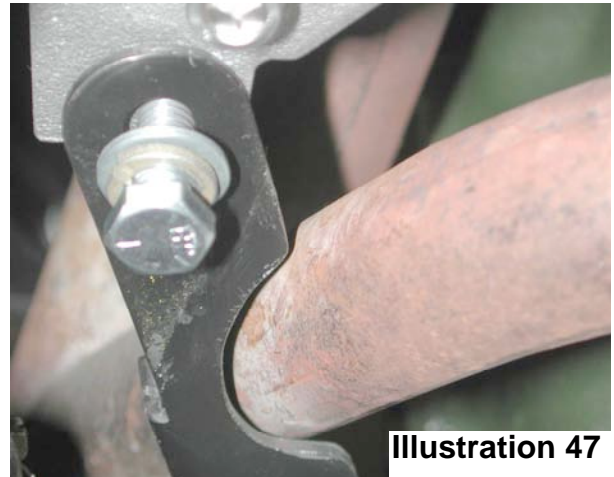

Illustration 47

Raise the car safely so that the underside of the engine can be reached. Find the notched spacer, a 5/16 washer, 5/16 lock washer and 5/16-18 nut. Install these on the 5/16-18 x 2in bolt. Tighten this bolt using a 1/2in wrench and socket with 6in extension. See Illustration 48

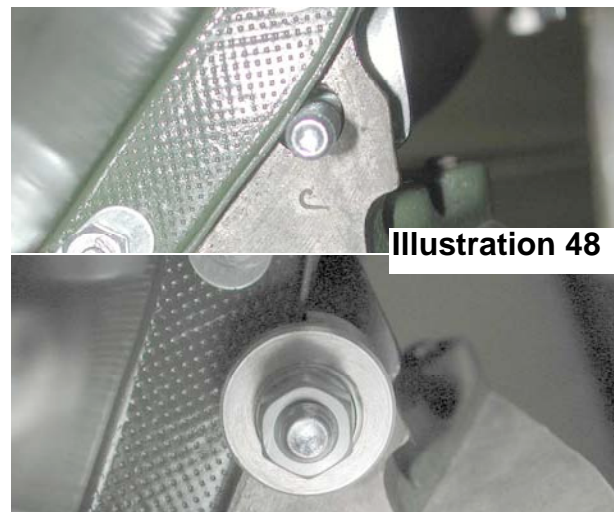

Illustration 48

Installation Instructions

The notch on the spacer allows the spacer to seat against the bottom of the engine casting without interfering with the oil pan. Tighten the bracket to the supercharger intake manifold using a 1/2in socket.

38. If the vehicle is running a cross-flow radiator then move on to the next step. There are two coolant hoses supplied in this kit. One (Moss #470-385) is a replacement hose for a vertical-flow radiator and the other (Moss #470-395) is for the cross-flow radiator. Cut the hose for the vertical-flow radiator right after the elbow. Refer to the illustrations of the pre-modified hose and modified hose with dimensions to determine where to cut. Illustration 49.



Illustration 49

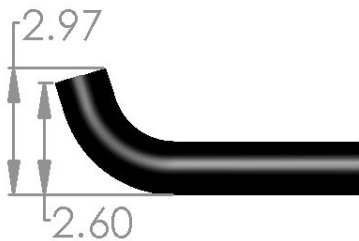

It is always best to cut the hose too long, rather than too short, so that it can be trimmed away as needed. Insert the plastic hose coupling into the cut end of the hose. Insert the other end of the coupling into the cross-flow radiator hose and orient the two hose as shown. Some silicone lubricant will make this assembly easier. Illustration 50.



Illustration 50



Illustration 50 con't

Install the two hose clamps(provided) at the coupling and fit it to the car. The upper portion will attach to the water pump and will be pulled away from the belt(in a later step) at the front supercharger support brace. Mock up the hose assembly and make sure that the it is the correct length.

39. If your car is running a vertical-flow radiator then move on to the next step. A new "lower tube to water pump" coolant hose (Moss #470-395) has been supplied in this kit and should be replaced at your discretion.

40. Attach the coolant hose (if replaced) to the water pump using one of the hose clamps provided in the kit. Attach the heater return line to the smaller hose on the lower coolant hose using the original hose clamp. Cross-flow radiator cars only: Attach the hose to the cross over tube using a supplied hose clamp.

41. Find the plastic strap, two 10-32 x .75in screw and two 10-32 nyloc nuts. Fit the strap around the coolant hose that goes into the water pump and attach the strap to the front supercharger brace using the screws and nuts. Tighten using a medium screw driver and a 3/8in wrench or socket. Illustration 51

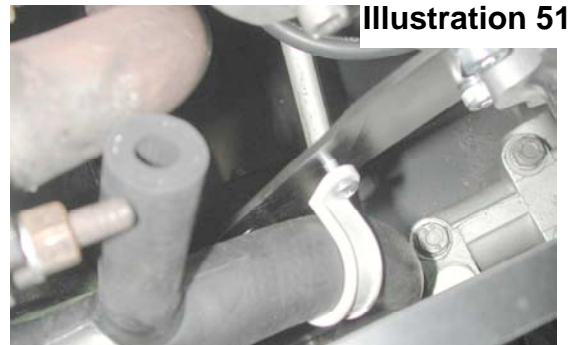

Illustration 51

Installation Instructions

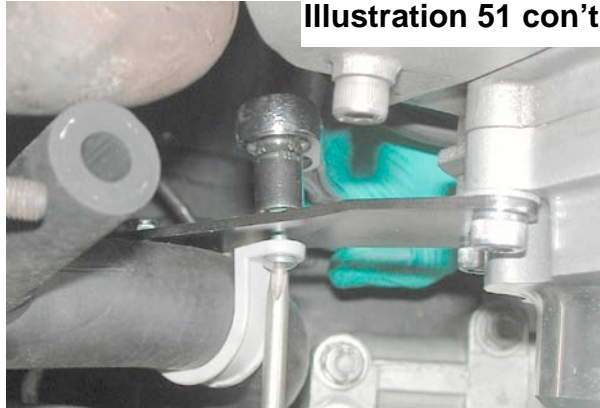

Illustration 51 con't

42. Install the 4-rib serpentine belt by first inserting it between the water pump pulley and the fixed idler pulley. The belt goes in a lot easier if the water pump pulley is being turned by hand. Illustration 52



Illustration 52



Wrap the belt under the fixed idler and over the alternator pulley. Illustration 53



Illustration 53

Lay the belt over the dynamic tensioner and then feed it under the crank pulley. Illustration 54

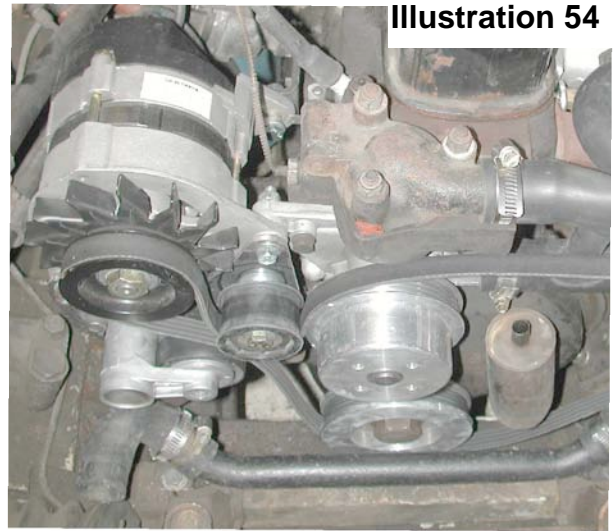

Illustration 54

At this point the pulley on the supercharger should be the only one that the belt is not wrapped around. Get a friend to pull the dynamic tensioner away with a 3/8in drive ratchet. Illustration 55



Illustration 55

Put the car in neutral(if it isn't already). Walk the belt onto supercharger pulley using an 18mm socket and ratchet. Hold the belt against the pulley grooves and rotate the pulley clockwise until the belt is seated on the pulley. Release the dynamic tensioner. See Illustration 56. Once installed the drive belt path should look like Illustration 57. Rotate the pulley manually more and watch the belt as it goes over the alternator/generator pulley, under the idler pulley and over the water pump pulley. Make sure that the alternator pulley is aligned properly and that the belt stays in the grooves. Also, check where the belt rides on the dynamic tensioner pulley. If necessary add or subtract shims from the alternator/generator mounting as needed. Remove the belt before loosening the alternator or generator. Repeat this inspection after the car is running.

Installation Instructions

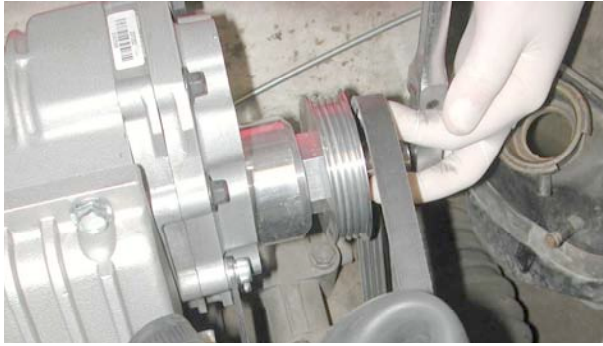

Illustration 56

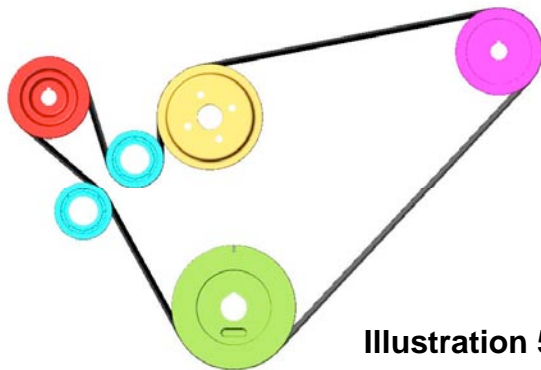
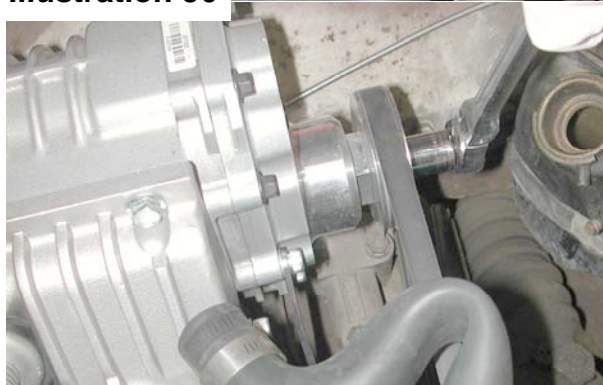

Illustration 57

43. Pull the air cleaner out of the box and disassemble it. Remove the protective plastic from the metal. Apply thread lock to the two 5/16-18 x 1 in bolts. The bolts go first through two 5/16 flat washers, then the backing plate of the air cleaner (from what will be the inside of the air cleaner), then through the cork gasket, then the throttle cable plate and finally through the thin paper gasket to the carburetor. Illustration 58

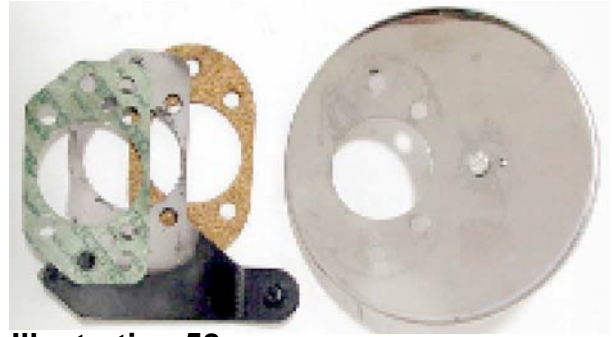

Illustration 58



Install the assembly on the carburetor, tighten snugly using a 1/2 in socket.

44. Install the new throttle cable. The cable has to be removed from the cable housing before it can attach to the linkage inside the foot well and fed through to the engine bay. Lubricate the cable with automotive grade grease before feeding it back through the housing.

45. Slip the throttle cable through the top hole on the throttle cable bracket, over the bellcrank, and through the trunion. Lock the cable in with the trunion bolt using a 9/32 in wrench. Check travel - make sure you get full range of motion, both wide open throttle and closed throttle. You will need to verify the same on the choke. Illustration 59



Illustration 59

Installation Instructions

46. If your choke cable is good, you can re-use it. If it is frayed or damaged then replace it with the included cable. The original routing of the choke will work well with the position of the carburetor. Now route the cable to the carburetor, feed it through the lower hole on the throttle cable bracket, and the trunion and tighten using a 9/32in and 5/16in wrenches. Check travel - make sure you get full range of motion, both wide open choke and closed choke. If necessary, the choke cable can be trimmed. Illustration 60

Illustration 60



47. Install the cap and air filter element onto the air cleaner backing plate. Leave the nut finger tight.

48. Included in the supercharger system are two new 1/4in fuel lines and a new fuel filter. Connect the shorter fuel line(11in) to the "IN" side of the fuel filter and the longer fuel line(26in) to the "OUT" side of the filter using two of the small hose clamps provided. Install the two provided p-clamps onto each section. Illustration 61

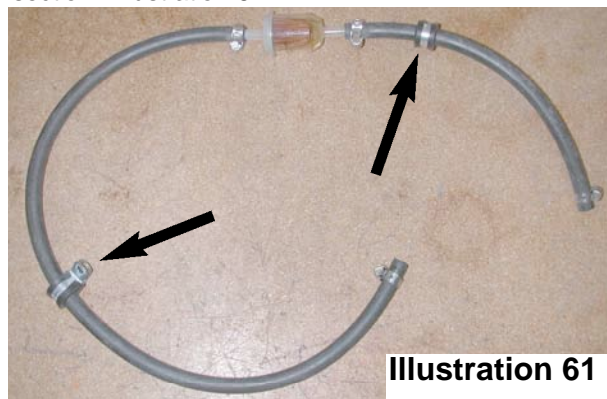
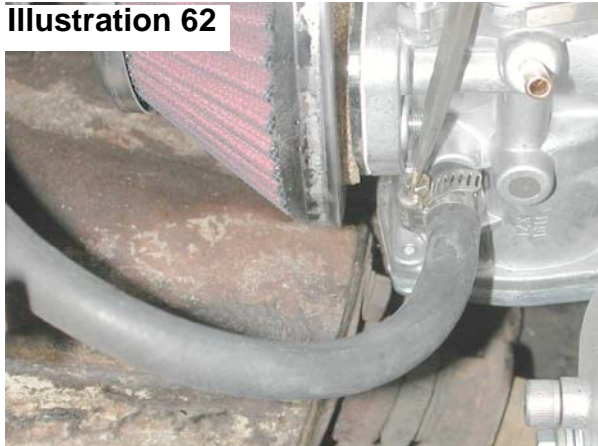

Illustration 61

Attach other end of the short fuel line to the fuel hard line that comes up just behind the coolant reservoir using a third small hose clamp. Route the fuel line around the air cleaner and attach it to the carburetor using the last small hose clamp. Make sure that there are no kinks in the hoses, and tighten all connections. Illustration 62

Illustration 62



49. Remove the nut that holds the cap and air filter element on and locate one of the P-clamps on the fuel line to the stud. Replace the nut and tighten with a 10mm wrench. Make sure that the fuel line has no kinks in it. Illustration 63



Illustration 63

50. Follow the hood release cable to the P-clamp mounted on the drivers side inner fender well. Remove the screw and nut that retain this clamp using a 90° screw driver and a 5/16in wrench. The nut is on the inside of the fender well. Illustration 64



Illustration 64

Find the 10-32 x .75in screw, #10 lock washer, and 10-32 nut. Locate the screw through the P-clamp on the fuel line, then through the P-clamp on the hood release cable and finally through the hole in the fender well. Tighten the screw down with the nut and lock washer. Make sure that the fuel line has no kinks in it. Illustration 65

Installation Instructions



Illustration 65

51. Find the molded hose that looks like a question mark. Cut approximately 1" off the curved end of this tube. Find the 5/16in to 1/2in plastic adaptor and insert into the straight end of the molded hose. Insert the other end of the adaptor into the 22in of 5/16in vacuum hose supplied in the kit. Illustration 66



Illustration 66



Fit the molded hose to the timing cover vent with the provided hose clamp and route the hose underneath the nose of the supercharger, up over the supercharger housing and then connect the other end to the carburetor. Illustration 67



Illustration 67



Attach the timing cover vent hose assembly to the plastic strap using one of the zip ties provided. Illustration 68



Illustration 68

52. Find the 29in of 1/4in vacuum hose and attach to the bowl vent on the carburetor. Route the hose to the charcoal canister in the same way as the original one using the provided zip ties. If a charcoal canister is not fitted to the vehicle then route the hose so that it points down and is away from the exhaust and/or steering, cutting the hose if necessary. Illustration 69



Illustration 69



Installation Instructions

53. Fit 24in of 5/32in vacuum hose on the barb at the carburetor. Route the hose to the vacuum advance on the distributor. If the vacuum advance uses a metal hard line tube it will have to be cut so that the provided hose can be pushed on. Illustration 70

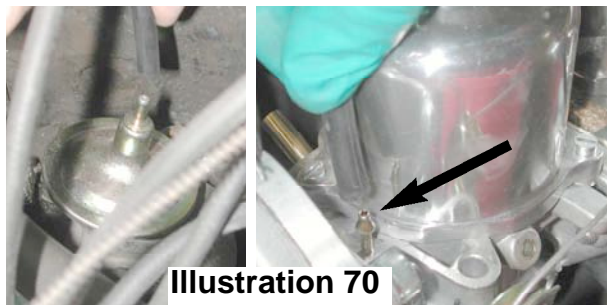

Illustration 70

54. There are three plugs on the manifold for a boost gage and other vacuum related devices.

55. Install the radiator. Make sure you already have a lower radiator hose clamp on the lower hose. Slip the radiator into place and start the four bolts using a 7/16in socket. Work at it gingerly. Once these are in place, return the 4 screws that hold the radiator shroud in place using a medium flat blade screw driver. Tighten the radiator bolts and screws. Now work the lower radiator hose over the fitting. Some lubricant may be helpful in slipping the hose over. There is not much room to work, so be patient. Make sure that there is clearance to the idler pulleys, the belt system, and the chassis. If everything is OK, tighten the hose clamp. Make sure there are no kinks in the hoses.

56. Install the upper radiator hose and the small coolant reservoir hose(if fitted). If your hoses or clamps show any age, we highly recommend replacing them.

57. Double check all radiator hose connections and clamps, and refill your radiator with the proper mix of coolant and water. Re-install the radiator cap.

58. Install the supplied spark plugs. We recommend using anti-seize on the threads. The gap is .035IN. Again, we highly recommend installing new spark plug wires, points, condenser and the cap and rotor. You will need a 13/16in socket on the new plugs.

59. Double check everything, especially all bolts, connections and fuel line clamps.

60. Check that your fire extinguisher is close and in good working order.

61. Re-connect the battery. Turn the ignition to on, and your fuel pump should pressurize. While the fuel system is pressurized check very carefully for fuel leaks.

62. Pull the choke to the full on position. Do not depress the throttle pedal. Start the car. When the car starts for the first time with the supercharger, bring the engine up to 2200 RPM, as the car warms, reduce the choke amount until the car is warm enough to run without it. With the supercharger pushing volumes of air into the car, you will have to use the choke more frequently and for longer periods of time than you may be used to. Do not roll into the throttle hard until the engine is fully warmed up, this can cause backfiring – the backfire valve is there to protect your engine as best it can.

63. Turn off the car and double check everything. After running it up to operating temperature, check everything again. Once it cools, you will need to re-check the coolant level.

64. Run your engine, and set your idle timing at 900 to 950RPM. Remove the vacuum advance, plug it, and set 9° of dynamic timing. Add timing at your own risk. Test the timing: When driving under load, listen very carefully for engine knocking (detonation), if you hear any sort of knocking, you will need to retard your timing. Our recommended numbers worked for the cars we tested, however every Spridget is a little different. Listen for knocks/detonation. A knocking engine will self-destruct fairly quickly.

65. After running your engine to full temperature, let it cool and then re-torque the intake nuts.

66. Enjoy your new Spridget Supercharger System! Please see www.mossmotors.com for all of your Spridget performance and accessory needs.