



THE
COMPONENTS
CATALOGUE

Automotive Parts & Accessories

MOSS

We've had many requests from fellow enthusiasts for a components catalogue, well here is the first edition (we hope you like it). Unlike our Model focused parts & accessories catalogues this catalogue is aimed at those enthusiasts that like to customize their vehicle(s) or are building a special or kit car.

This catalogue contains our range of products by type, showing all the variations of a product. Allowing you to select the right product, that either fits the application or you prefer purely because that's the one you like the look of. It also includes upgrade parts so that you can change the original parts for a modern (and improved) alternative, like upgrading to LED bulbs.

Parts are displayed by specification showing details of: Material, size, thread etc... to help you select the correct part. We are already working on the second edition adding many more parts. If you have any additions that you feel should be included please contact me and I will do what I can to include them. Until then have fun with your project(s)...



Owen Britton, Moss Bristol
obritton@moss-europe.co.uk



Contents

A	Dynalite83	Induction39-43	Spot & fog lamps50-51
Adhesive & bolt-on badges21	Dynamat34-35	Insulation products, exhaust17	Stop & tail light assemblies66-71
Air filters (induction)41-43	Dynamo C4083	Interior lamps64	Switches & controls92-94
Alternators83	E	K	T
B	Exhaust clamps16	Knob-less control cables11	Throttle linkage & fittings38
Batteries78-79	Exhaust sleeves & adaptors17	M	Throttle operating cables6-7
Battery boxes & trays79	F	Mirrors26-29	W
Battery cables & fittings82	Fan belts16	N	Wheels, tyres & roadside equipment23-25
Battery clamps & kits80	Flasher units, relays & solenoids90	Number plate fixings19	Windscreens washers98-99
Battery isolator & cut-off switches82	Front side & indicator Lamp56-60	Number plate lamps61-63	Wiper arms & parts100
Battery J bolts81	Fuse boxes & holders87	O	Wiper blades101
Bonnet release cables6	G	Oil coolers37	
Bonnet straps & pins18	Gauges84-86	P	
Boot rack & accessories22-23	General accessories29	Pipe working tools5	
Brake pipe4	Grille & bar badges20	R	
Brake pipe fittings5	H	Ram pipes (induction)39	
Brake servo fittings4	Hardtop storage caddy23	Reflectors65	
Brake servo kit4	Headlamp assemblies45	Rev limiters87	
Breather filters38	Headlamp bowls, harnesses & fittings48-49	Reverse lamps65	
Bulbs72-76	Headlamp conversion kits45-47	Revotec cooling fan components14-16	
C	Headlamp rims18	S	
Choke operating cables8-9	Headlamp units44	Screens & visors22	
Cigar lighter87	Heater operating cables12	Seat belt kits32-33	
Classic general lamps52-56	Horns91	Seat harnesses30-31	
Classic style seat belts33	Hydraulic hoses3	Speedo & tacho operating cables10-11	
Control cable fittings12	I		
D	Ignition system88-89		
Distributor components94-97			

SECTIONS	
Brake systems	03-05
Control cables	06-12
Cooling system	14-16
Exhaust	16-17
Exterior	18-29
Interior	29-35
Performance	37-43
Electrical	44-101
Ordering information	102
General hardware	103



LONDON
Unit 16, Hampton Business Park
Bolney Way, Feltham
TW13 6DB
London Tel
+44 (0) 20 8867 2020
E-mail
sales@moss-europe.co.uk
Fax
+44 (0) 20 8867 2030

Moss Website
moss-europe.co.uk



BRADFORD
Unit 12-13, Acorn Park Ind. Est.
Otley Road, Shipley
BD17 7SW
Bradford Tel
+44 (0) 1274 539 999
E-mail
bradford@moss-europe.co.uk
Fax
+44 (0) 1274 539 990

ebay
stores.ebay.co.uk/moss-europe-ltd



BRISTOL
1-3 Elton Street
Bristol
BS2 9EH
Bristol Tel
+44 (0) 117 923 2523
E-mail
bristol@moss-europe.co.uk
Fax
+44 (0) 117 942 8236

Facebook
facebook.com/mosseurope



MANCHESTER
111-117 Stockport Road
Stockport, Cheshire
SK3 0JE
Manchester Tel
+44 (0) 161 480 6402
E-mail
manchester@moss-europe.co.uk
Fax
+44 (0) 161 429 0349

Twitter
twitter.com/mosseurope



PARIS
7 rue Chaponval
ZAC du Cornouiller
78870 Bailly, France
Paris Tel
+33 (0) 1 30 80 20 30
E-mail
sales@moss-europe.fr
Fax
+33 (0) 1 30 80 21 50

Moss Paris Website
moss-europe.fr

Important notification of prices for 2014

Due to the volatility of world markets and currency fluctuations the prices in this catalogue are subject to change. Moss make every attempt to keep prices competitive and stable, however in common with all other suppliers in our industry, we reserve the right to alter these prices without prior notice. For the latest prices, please visit our website moss-europe.co.uk. Printed in the U.K. All rights reserved. No part of this publication may be reproduced, stored in a retrieval system, or transmitted in any form by any means, electronic, photocopying, recording or otherwise without prior written consent of Moss Europe Ltd. Please note: Product colours may vary slightly to samples featured in this catalogue, due to the limitations of colour printing.

All prices are per unit (unless otherwise stated) and include (UK) VAT at 20% (where applicable). Please note EU countries may be charged at their local VAT rate, countries outside the EU will not be charged VAT. See the ordering information or our website for further details. Prices are correct at the time of going to print, postage & packaging is not included. E&OE.



Brake & Clutch Hoses - HYDRAULIC HOSES

Hoses - Rubber

Material	Hose Length	End Type No.1	End Type No.2	Part No	Price (ea)
Rubber	6.25"	3/8 UNF female	3/8 banjo	GVP1009	£11.60
Rubber	10.75"	3/8 UNF male	3/8 banjo	GBH110	£10.96
Rubber	12"	3/8 UNF male	3/8 banjo	GBH157	£7.96
Rubber	14.5"	3/8 UNF male	3/8 banjo	BHA4139	£12.95
Rubber	6"	3/8 UNF male	3/8 UNF male	GBH250	£4.55
Rubber	7.25"	3/8 UNF male	3/8 UNF male	GBH178	£8.15
Rubber	8.75"	3/8 UNF male	3/8 UNF male	GBH159	£5.26
Rubber	9.25"	3/8 UNF male	3/8 UNF male	GBH177	£8.15
Rubber	9.5"	3/8 UNF male	3/8 UNF male	GBH175	£12.65
Rubber	9.5"	3/8 UNF male	3/8 UNF male	GBH176	£11.95
Rubber	10.5"	3/8 UNF male	3/8 UNF male	GBH206	£10.96
Rubber	11"	3/8 UNF male	3/8 UNF male	GBH166	£9.50
Rubber	12.5"	3/8 UNF male	3/8 UNF male	GBH172	£7.10
Rubber	12.75"	3/8 UNF male	3/8 UNF male	GBH158	£6.95
Rubber	13.25"	3/8 UNF male	3/8 UNF male	GBH216	£13.96
Rubber	6.25"	3/8 UNF male	3/8 UNF female	GVP1020	£7.45
Rubber	10"	3/8 UNF male	3/8 UNF female	GBH249	£5.70
Rubber	11.5"	3/8 UNF male	3/8 UNF female	GBH170	£6.20
Rubber	11.5"	3/8 BSF male	3/8 BSF female	17H7719	£9.55
Rubber	11.5"	3/8 UNF male	3/8 UNF female	108595	£27.95
Rubber	12.25"	3/8 UNF male	3/8 UNF female	GBH108	£5.45
Rubber	12.5"	3/8 UNF male	3/8 UNF female	GBH104	£11.75
Rubber	10.75"	3/8 UNF male	7/16 UNF female	108596Z	£13.85
Rubber	8"	7/16 UNF male	7/16 UNF female	GVP1001	£8.95
PVC	13.5"	7/16 UNF male	7/16 UNF female	140420	£17.95





Hoses - Braided

Material	Hose Length	End Type No.1	End Type No.2	Part No	Price (ea)
Stainless Steel	6.25"	3/8 UNF female	3/8 banjo	GAC8447X	£13.50
Stainless Steel	12"	3/8 UNF male	3/8 banjo	GBH157SS	£23.95
Stainless Steel	10.75"	3/8 UNF male	3/8 banjo	GBH110SS	£30.95
Stainless Steel	14.5"	3/8 UNF male	3/8 banjo	BHA4139SS	£25.96
Stainless Steel	8.75"	3/8 UNF male	3/8 UNF male	GBH159SS	£23.95
Stainless Steel	11"	3/8 UNF male	3/8 UNF male	GBH166SS	£18.95
Stainless Steel	9.5"	3/8 UNF male	3/8 UNF male	GBH175SS	£18.95
Stainless Steel	11.75"	3/8 UNF male	3/8 UNF male	TT3142	£17.35
Stainless Steel	12.75"	3/8 UNF male	3/8 UNF male	GBH158SS	£24.95
Stainless Steel	12.5"	3/8 UNF male	3/8 UNF female	GBH104SS	£21.60
Stainless Steel	6.25"	3/8 UNF male	3/8 UNF female	GAC8446X	£10.96
Stainless Steel	12"	3/8 UNF male	7/16 UNF female	TT3042	£22.96
Stainless Steel	14"	7/16 UNF female	7/16 UNF female	TT3141	£26.95
Stainless Steel	8"	7/16 UNF male	7/16 UNF female	TT3041	£36.95
Stainless Steel	13.5"	7/16 UNF male	7/16 UNF female	TT3241	£28.96



Hose Fittings

			
Description Banjo	Description Nut, Thin	Description Nut, Thin	Description Washer
Material Steel	Material Steel	Material Steel	Material Copper
Size 3/8"	Size 5/8" UNF	Size 3/8" UNF	Size 3/8" ID x 5/8" OD
Part No C5192A	Part No 2K8686	Part No NT606041	Part No 233220A
Price (ea) £4.96	Price (ea) £0.90	Price (ea) £0.40	Price (ea) £0.50
			
Description Washer	Description Washer, Locking	Description Washer, Locking	
Material Copper	Material Steel	Material Steel	
Size 7/16" ID x 7/10" OD	Size 5/8" UNF	Size 3/8" ID	
Part No 3H550	Part No WE600101	Part No GHF323	
Price (ea) £0.46	Price (ea) £0.30	Price (ea) £0.10	



Brake Servos - BRAKE SERVO KIT

Remote Brake Servo Kits - Single Line

Single line brake servo kits include: Brackets, pipes and fittings. A manifold adaptor will be required separately, and a one-way valve is recommended for the servo hose.



Description Lockheed
Boost Ratio 1.9:1
Part No TT3949
Price £179.95



Description Aftermarket
Boost Ratio 1.9:1
Part No TT3949Z
Price £98.95



Description Lockheed
Boost Ratio 3:1
Part No LKLE10117
Price £175.00



Description Aftermarket
Boost Ratio 3:1
Part No LKLE10117Z
Price £114.95

Brake Servos - BRAKE SERVO FITTINGS



Description One Way Valve
Type Inline
Part No 148479
Price (ea) £21.95



Description Manifold Adaptor
Type Plain
Thread 5/8 UNF
Part No 12H1405
Price (ea) £7.15



Description Manifold Adaptor
Type One Way Valve
Thread 5/8 UNF
Part No ADU1402
Price (ea) £15.25



Description Washer, Sealing
Material Fibre
Thread 5/8" x 1.1/6"
Part No 1B3664
Price (ea) £0.25

Hydraulic Pipe & Fittings - BRAKE PIPE

Kunifer & Copper Brake Pipe

Making your own brake pipes can be easier than trying to source the correct length ready-made items. Available in Kunifer (copper-nickel alloy), or copper.

MPKF325



Description	Length	Pipe Size	Part No	Price
Copper Nickel	25FT (7.62m)	3/16"	MPKF125	£20.95
Copper Nickel	25FT (7.62m)	1/4"	MPKF225	£35.95
Copper Nickel	25FT (7.62m)	5/16"	MPKF325	£46.96

MPCP325



Description	Length	Pipe Size	Part No	Price
Copper	25FT (7.62m)	3/16"	MPCP125	£15.95
Copper	25FT (7.62m)	1/4"	MPCP225	£22.94
Copper	25FT (7.62m)	5/16"	MPCP325	£29.95

Unions & Connectors - BRAKE PIPE FITTINGS



Description	Pipe Nut, Female
Material	Brass
Pipe Size	3/16"
Thread	3/8 UNF
Part No	AEHU1A
Price (ea)	£1.45



Description	Pipe Nut, Female
Material	Brass
Pipe Size	3/16"
Thread	M10
Part No	AEHU2A
Price (ea)	£1.40



Description	Pipe Nut, Female
Material	Brass
Pipe Size	1/4"
Thread	7/16 UNF
Part No	AEHU4A
Price (ea)	£2.26



Description	Pipe Nut, Male
Material	Brass
Pipe Size	3/16"
Thread	3/8 BSF
Part No	AEHU3
Price (ea)	£2.35



Description	Pipe Nut, Male
Material	Brass
Pipe Size	3/16"
Thread	7/16 UNF
Part No	AEHU14
Price (ea)	£1.90



Description	Pipe Nut, Male
Material	Brass
Pipe Size	3/16"
Thread	7/16 UNF
Part No	AEHU7
Price (ea)	£2.20



Description	Pipe Nut, Male
Material	Brass
Pipe Size	3/16"
Thread	M10 x 1
Part No	AEHU2
Price (ea)	£1.30



Description	Pipe Nut, Male
Material	Brass
Pipe Size	1/4"
Thread	3/8 UNF
Part No	AEHU1
Price (ea)	£1.20



Description	Pipe Nut, Male
Material	Brass
Pipe Size	5/16"
Thread	1/4 BSP
Part No	AEHU40
Price (ea)	£3.55



Description	Union, Male to Male
Material	Steel
Pipe Size	3/16"
Thread	3/8 UNF
Part No	ACB5559
Price (ea)	£2.86



Specialist Tools - PIPE WORKING TOOLS

Making Up Brake Pipes

Making up brake and fuel pipes can be a tricky job. Getting tight radii curves into the pipes without the proper tools can lead to kinking of the pipes. Our range of pipe work tools ensures a quality finish without damage. A full range of pipes & fittings are available, please see moss-europe.co.uk



Description	Pipe Cutter
Part No	CTR023
Price (ea)	£4.15

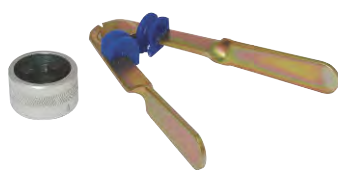

Description	Pipe Bending & De-burring Tool Set
Part No	MTR1331
Price (ea)	£29.95



Description	Pipe Flaring Tool (In Situ)
Part No	LT3434
Price (ea)	£37.96



Description	Pipe Bending Tool
Part No	MTR1332
Price (ea)	£51.95



Description	Pipe Bending Pliers
Part No	MTR1330
Price (ea)	£25.96



Description	Pipe Bending Tool (Hand or Vice Mounted)
Part No	LT3483
Price (ea)	£19.96



Description	Pipe Flaring Tool (Vice Mounted)
Part No	MTR1333
Price (ea)	£164.95

Control Cables

The correct length and type of control cables aid driver interaction and improve car feel and driveability. Most cables can be carefully cut down if your required length is not available. When selecting a cable please ensure you allow enough length for engine movement. Cables feature a spiral metal outer cable, some are supplied with a black plastic cover. Inner cables are either solid or multi-strand depending on application. Use multi-strand inner cables for pull controls where a return spring is also used. Use a solid inner cable for push/pull controls.

Bonnet Cables - BONNET RELEASE CABLES

			
Cable Style Single	Cable Style Single	Cable Style Single	Cable Style Single
Outer Cable Plastic	Outer Cable Plastic	Outer Cable Plastic	Outer Cable Plastic
Inner Cable (Strands) Multi	Inner Cable (Strands) Multi	Inner Cable (Strands) Multi	Inner Cable (Strands) Multi
Outer Cable Length 43" (109cm)	Outer Cable Length 50" (127 cm)	Outer Cable Length 57" (144 cm)	Outer Cable Length 65" (165 cm)
Inner Cable Length 40" (101cm)	Inner Cable Length 60" (152 cm)	Inner Cable Length 62" (157 cm)	Inner Cable Length 69" (175 cm)
Knob M	Knob M	Knob M	Knob M
Panel Hole Diameter 1/2" (12.5mm)	Panel Hole Diameter 3/8" (10mm)	Panel Hole Diameter 3/8" (10mm)	Panel Hole Diameter 3/8" (10mm)
Part No XKC3984	Part No CHA460	Part No AHH6426	Part No RTC2647
Price (ea) £10.90	Price (ea) £9.95	Price (ea) £8.70	Price (ea) £15.60

			
Cable Style Single	Cable Style Single	Cable Style Single	
Outer Cable Plastic	Outer Cable Plastic	Outer Cable Plastic	
Inner Cable (Strands) Solid	Inner Cable (Strands) Multi	Inner Cable (Strands) Multi	
Outer Cable Length 65" (165 cm)	Outer Cable Length 50" (127 cm)	Outer Cable Length 57" (144 cm)	
Inner Cable Length 73" (185 cm)	Inner Cable Length 60" (152 cm)	Inner Cable Length 62" (157 cm)	
Knob M	Knob N	Knob N	
Panel Hole Diameter 3/8" (10mm)	Panel Hole Diameter 3/8" (10mm)	Panel Hole Diameter 3/8" (10mm)	
Part No AHC19Z	Part No AHA5653B	Part No AHH6426B	
Price (ea) £9.25	Price (ea) £9.50	Price (ea) £8.76	

Throttle Cables - THROTTLE OPERATING CABLES

Throttle Cable Key		ID. No.	Description
1	Bare	8	Stepped collar
2	Bare with adjuster	9	Stepped collar with nipple
3	Nipple	10	Threaded adjuster and nipple
4	Nipple, with collar 4 inches from end on the outer cable	11	Threaded adjuster and fork
5	Nipple, collar and washer at the end on the outer cable	12	Forked end
6	Plastic retainer	13	Square boss
7	Collar		

			
Cable Style Single	Cable Style Single	Cable Style Single	Cable Style Single
Outer Cable Plastic	Outer Cable Plastic	Outer Cable Plastic	Outer Cable Plastic
Inner Cable (Strands) Multi	Inner Cable (Strands) Multi	Inner Cable (Strands) Multi	Inner Cable (Strands) Multi
Outer Cable Length 23" (58cm)	Outer Cable Length 24" (60cm)	Outer Cable Length 26" (66cm)	Outer Cable Length 26" (66cm)
Inner Cable Length 30" (76cm)	Inner Cable Length 32" (81cm)	Inner Cable Length 30" (76cm)	Inner Cable Length 33" (83cm)
End Type No.1 6	End Type No.1 8	End Type No.1 8	End Type No.1 8
End Type No.2 9	End Type No.2 9	End Type No.2 9	End Type No.2 9
Part No SBB10126	Part No AHA5746	Part No NAM7914	Part No MCR104
Price (ea) £9.95	Price (ea) £5.95	Price (ea) £5.35	Price (ea) £10.36



Cable Style	Single
Outer Cable	Plastic
Inner Cable (Strands)	Multi
Outer Cable Length	26" (66cm)
Inner Cable Length	34" (86cm)
End Type No.1	7
End Type No.2	9
Part No	ACA8098
Price (ea)	£4.15



Cable Style	Single
Outer Cable	Plastic
Inner Cable (Strands)	Multi
Outer Cable Length	26" (66cm)
Inner Cable Length	34" (86cm)
End Type No.1	8
End Type No.2	9
Part No	21G5077
Price (ea)	£9.55



Cable Style	Single
Outer Cable	Plastic
Inner Cable (Strands)	Multi
Outer Cable Length	26" (66cm)
Inner Cable Length	39" (99cm)
End Type No.1	1
End Type No.2	9
Part No	AHH5625
Price (ea)	£3.95



Cable Style	Single
Outer Cable	Plastic
Inner Cable (Strands)	Multi
Outer Cable Length	29" (73cm)
Inner Cable Length	35" (88cm)
End Type No.1	10
End Type No.2	9
Part No	UKC3663
Price (ea)	£11.65



Cable Style	Single
Outer Cable	Plastic
Inner Cable (Strands)	Multi
Outer Cable Length	31" (78cm)
Inner Cable Length	38" (96cm)
End Type No.1	8
End Type No.2	9
Part No	CAHT85
Price (ea)	£6.58



Cable Style	Single
Outer Cable	Plastic
Inner Cable (Strands)	Multi
Outer Cable Length	32" (81cm)
Inner Cable Length	36" (91cm)
End Type No.1	12
End Type No.2	4
Part No	149005
Price (ea)	£12.65



Cable Style	Single
Outer Cable	Plastic
Inner Cable (Strands)	Multi
Outer Cable Length	33" (83cm)
Inner Cable Length	37" (93cm)
End Type No.1	11
End Type No.2	9
Part No	CHA405
Price (ea)	£9.95



Cable Style	Single
Outer Cable	Plastic
Inner Cable (Strands)	Multi
Outer Cable Length	35" (88cm)
Inner Cable Length	40" (101cm)
End Type No.1	10
End Type No.2	9
Part No	UKC5875
Price (ea)	£11.20



Cable Style	Single
Outer Cable	Plastic
Inner Cable (Strands)	Multi
Outer Cable Length	36" (91cm)
Inner Cable Length	41" (104cm)
End Type No.1	12
End Type No.2	4
Part No	160308
Price (ea)	£12.46



Cable Style	Single
Outer Cable	Plastic
Inner Cable (Strands)	Multi
Outer Cable Length	36" (91cm)
Inner Cable Length	45" (114cm)
End Type No.1	1
End Type No.2	9
Part No	AHH8462
Price (ea)	£5.95



Cable Style	Single
Outer Cable	Plastic
Inner Cable (Strands)	Multi
Outer Cable Length	37" (93cm)
Inner Cable Length	43" (109cm)
End Type No.1	11
End Type No.2	9
Part No	BHH1648
Price (ea)	£8.95



Cable Style	Single
Outer Cable	Plastic
Inner Cable (Strands)	Multi
Outer Cable Length	37" (93cm)
Inner Cable Length	46" (116cm)
End Type No.1	13
End Type No.2	8
Part No	BHH1120
Price (ea)	£8.65



Cable Style	Single
Outer Cable	Plastic
Inner Cable (Strands)	Multi
Outer Cable Length	40" (101cm)
Inner Cable Length	44" (111cm)
End Type No.1	11
End Type No.2	9
Part No	RTC2922
Price (ea)	£11.65



Cable Style	Single
Outer Cable	Plastic
Inner Cable (Strands)	Multi
Outer Cable Length	42" (106cm)
Inner Cable Length	45" (114cm)
End Type No.1	12
End Type No.2	5
Part No	160309
Price (ea)	£15.60



Cable Style	Single
Outer Cable	Plastic
Inner Cable (Strands)	Multi
Outer Cable Length	45" (114cm)
Inner Cable Length	56" (142cm)
End Type No.1	3
End Type No.2	2
Part No	LP4000X
Price (ea)	£17.56



Cable Style	Single
Outer Cable	Plastic
Inner Cable (Strands)	Multi
Outer Cable Length	51" (129cm)
Inner Cable Length	57" (144cm)
End Type No.1	11
End Type No.2	8
Part No	149004
Price (ea)	£10.85

Choke Cables - CHOKE OPERATING CABLES



Cable Style	Single
Outer Cable	Metal
Inner Cable (Strands)	Multi
Outer Cable Length	27" (68cm)
Inner Cable Length	32" (81cm)
Knob	C
Panel Hole Diameter	3/8" (10mm)
Part No	21A2329
Price (ea)	£10.55



Cable Style	Single
Outer Cable	Metal
Inner Cable (Strands)	Multi
Outer Cable Length	30" (76cm)
Inner Cable Length	33" (83cm)
Knob	I
Panel Hole Diameter	3/8" (10mm)
Part No	21A1202
Price (ea)	£24.95



Cable Style	Single
Outer Cable	Metal
Inner Cable (Strands)	Multi
Outer Cable Length	32" (81cm)
Inner Cable Length	35" (88cm)
Knob	A
Panel Hole Diameter	1/2" (12.5mm)
Part No	ACA8019
Price (ea)	£25.50



Cable Style	Single
Outer Cable	Metal
Inner Cable (Strands)	Multi
Outer Cable Length	32" (81cm)
Inner Cable Length	35" (88cm)
Knob	C
Panel Hole Diameter	1/2" (12.5mm)
Part No	CHA288
Price (ea)	£10.06



Cable Style	Single
Outer Cable	Metal
Inner Cable (Strands)	Multi
Outer Cable Length	32" (81cm)
Inner Cable Length	35" (88cm)
Knob	D
Panel Hole Diameter	1/2" (12.5mm)
Part No	AHA7748
Price (ea)	£8.95



Cable Style	Single
Outer Cable	Metal
Inner Cable (Strands)	Multi
Outer Cable Length	39" (99cm)
Inner Cable Length	43" (109cm)
Knob	N/A
Panel Hole Diameter	1/2" (12.5mm)
Part No	400627
Price (ea)	£39.95



Cable Style	Single
Outer Cable	Metal
Inner Cable (Strands)	Multi
Outer Cable Length	43" (109cm)
Inner Cable Length	48" (121cm)
Knob	A
Panel Hole Diameter	1/2" (12.5mm)
Part No	401900/1
Price (ea)	£39.95



Cable Style	Single
Outer Cable	Metal
Inner Cable (Strands)	Multi
Outer Cable Length	44" (111cm)
Inner Cable Length	50" (129cm)
Knob	D
Panel Hole Diameter	1/2" (12.5mm)
Part No	BHH651
Price (ea)	£13.66



Cable Style	Single
Outer Cable	Metal
Inner Cable (Strands)	Multi
Outer Cable Length	44" (111cm)
Inner Cable Length	52" (132cm)
Knob	A
Panel Hole Diameter	1/2" (12.5mm)
Part No	AHH5333
Price (ea)	£11.95



Cable Style	Single
Outer Cable	Metal
Inner Cable (Strands)	Multi
Outer Cable Length	46" (116cm)
Inner Cable Length	50" (127cm)
Knob	D
Panel Hole Diameter	1/2" (12.5mm)
Part No	BHH653
Price (ea)	£9.35



Cable Style	Single
Outer Cable	Metal
Inner Cable (Strands)	Multi
Outer Cable Length	50" (127cm)
Inner Cable Length	54" (137cm)
Knob	D
Panel Hole Diameter	1/2" (12.5mm)
Part No	AHC67
Price (ea)	£9.76



Cable Style	Single
Outer Cable	Metal
Inner Cable (Strands)	Multi
Outer Cable Length	51" (129cm)
Inner Cable Length	54" (137cm)
Knob	A
Panel Hole Diameter	1/2" (12.5mm)
Part No	AHH5336
Price (ea)	£11.95



Cable Style	Single
Outer Cable	Metal
Inner Cable (Strands)	Multi
Outer Cable Length	51" (129cm)
Inner Cable Length	54" (137cm)
Knob	B
Panel Hole Diameter	1/2" (12.5mm)
Part No	AHH6725
Price (ea)	£7.25



Cable Style	Single
Outer Cable	Metal
Inner Cable (Strands)	Multi
Outer Cable Length	53" (134cm)
Inner Cable Length	60" (152cm)
Knob	A
Panel Hole Diameter	1/2" (12.5mm)
Part No	BHA4084
Price (ea)	£16.96



Cable Style	Single
Outer Cable	Metal
Inner Cable (Strands)	Multi
Outer Cable Length	57" (144cm)
Inner Cable Length	66" (167cm)
Knob	X
Panel Hole Diameter	1/2" (12.5mm)
Part No	331-410
Price (ea)	£38.95



Cable Style	Single
Outer Cable	Metal
Inner Cable (Strands)	Multi
Outer Cable Length	57" (144cm)
Inner Cable Length	67" (170cm)
Knob	F
Panel Hole Diameter	1/2" (12.5mm)
Part No	331-380
Price (ea)	£49.96



Cable Style	Single
Outer Cable	Metal
Inner Cable (Strands)	Multi
Outer Cable Length	57" (144cm)
Inner Cable Length	67" (170cm)
Knob	G
Panel Hole Diameter	1/2" (12.5mm)
Part No	331-290
Price (ea)	£32.95



Cable Style	Single
Outer Cable	Metal
Inner Cable (Strands)	Solid
Outer Cable Length	38" (96cm)
Inner Cable Length	42" (106cm)
Knob	B
Panel Hole Diameter	1/2" (12.5mm)
Part No	ACA8227
Price (ea)	£18.95



Cable Style	Single
Outer Cable	Plastic
Inner Cable (Strands)	Multi
Outer Cable Length	27" (68cm)
Inner Cable Length	32" (81cm)
Knob	E
Panel Hole Diameter	3/8" (10mm)
Part No	MCR106
Price (ea)	£15.60



Cable Style	Single
Outer Cable	Plastic
Inner Cable (Strands)	Multi
Outer Cable Length	30" (76cm)
Inner Cable Length	35" (88cm)
Knob	E
Panel Hole Diameter	3/8" (10mm)
Part No	BHH2064
Price (ea)	£11.95



Cable Style	Single
Outer Cable	Plastic
Inner Cable (Strands)	Multi
Outer Cable Length	30" (76cm)
Inner Cable Length	35" (88cm)
Knob	E
Panel Hole Diameter	3/8" (10mm)
Part No	MCR105
Price (ea)	£11.65



Cable Style	Single
Outer Cable	Plastic
Inner Cable (Strands)	Multi
Outer Cable Length	41" (104cm)
Inner Cable Length	48" (121cm)
Knob	D
Panel Hole Diameter	1/2" (12.5mm)
Part No	BHH650
Price (ea)	£10.96



Cable Style	Single
Outer Cable	Plastic
Inner Cable (Strands)	Multi
Outer Cable Length	42" (106cm)
Inner Cable Length	45" (114cm)
Knob	B
Panel Hole Diameter	1/2" (12.5mm)
Part No	BHH1121
Price (ea)	£14.10



Cable Style	Single
Outer Cable	Plastic
Inner Cable (Strands)	Multi
Outer Cable Length	44" (111cm)
Inner Cable Length	50" (127cm)
Knob	D
Panel Hole Diameter	1/2" (12.5mm)
Part No	TKC2772
Price (ea)	£14.35



Cable Style	Single
Outer Cable	Plastic
Inner Cable (Strands)	Solid
Outer Cable Length	32" (81cm)
Inner Cable Length	35" (88cm)
Knob	B
Panel Hole Diameter	3/8" (10mm)
Part No	2A2086
Price (ea)	£8.10



Cable Style	Twin
Outer Cable	Plastic
Inner Cable (Strands)	Multi
Outer Cable Length	38" & 30" (96 & 76cm)
Inner Cable Length	42" & 34" (106 & 86cm)
Knob	H
Panel Hole Diameter	1/2" (12.5 mm)
Part No	218301
Price (ea)	£78.00



Cable Style	Twin
Outer Cable	Plastic
Inner Cable (Strands)	Multi
Outer Cable Length	40" & 31" (101 & 78 cm)
Inner Cable Length	44" & 35" (111 & 88cm)
Knob	H
Panel Hole Diameter	1/2" (12.5 mm)
Part No	214672
Price (ea)	£78.00



Cable Style	Twin
Outer Cable	Plastic
Inner Cable (Strands)	Multi
Outer Cable Length	48" & 33" (121 & 83cm)
Inner Cable Length	52" & 38" (132 & 96cm)
Knob	H
Panel Hole Diameter	1/2" (12.5 mm)
Part No	219258
Price (ea)	£90.00



Cable Style	Twin
Outer Cable	Plastic
Inner Cable (Strands)	Multi
Outer Cable Length	48" & 41" (121 & 104cm)
Inner Cable Length	52" & 46" (132 & 116cm)
Knob	H
Panel Hole Diameter	1/2" (12.5 mm)
Part No	214888
Price (ea)	£78.00



Cable Style	Twin
Outer Cable	Plastic
Inner Cable (Strands)	Solid
Outer Cable Length	41" & 32" (104 & 81cm)
Inner Cable Length	45" & 36" (114 & 91cm)
Knob	J
Panel Hole Diameter	1/2" (12.5 mm)
Part No	UKC2121
Price (ea)	£90.00



Speedo & Tacho Cables - SPEEDO & TACHO OPERATING CABLES



Outer Cable	Plastic
Cable Length	26" (66cm)
End Type No.1	D
End Type No.2	E
Part No	GSD152
Price (ea)	£10.90



Outer Cable	Plastic
Cable Length	29" (73cm)
End Type No.1	A
End Type No.2	D
Part No	GSD402
Price (ea)	£11.26



Outer Cable	Plastic
Cable Length	33" (83cm)
End Type No.1	A
End Type No.2	D
Part No	GSD102
Price (ea)	£7.75



Outer Cable	Plastic
Cable Length	39" (99cm)
End Type No.1	D
End Type No.2	E
Part No	GSD249
Price (ea)	£9.95



Outer Cable	Plastic
Cable Length	42" (106cm)
End Type No.1	A
End Type No.2	D
Part No	GSD487
Price (ea)	£12.50



Outer Cable	Plastic
Cable Length	45" (114cm)
End Type No.1	D
End Type No.2	E
Part No	GSD103
Price (ea)	£7.96



Outer Cable	Plastic
Cable Length	45" (114cm)
End Type No.1	A
End Type No.2	G
Part No	GSD287
Price (ea)	£17.56



Outer Cable	Plastic
Cable Length	48" (121cm)
End Type No.1	D
End Type No.2	E
Part No	GSD111
Price (ea)	£8.50



Outer Cable	Plastic
Cable Length	48" (121cm)
End Type No.1	A
End Type No.2	D
Part No	GSD415
Price (ea)	£11.05



Outer Cable	Plastic
Cable Length	48" (121cm)
End Type No.1	A
End Type No.2	G
Part No	GSD410
Price (ea)	£19.96



Outer Cable	Plastic
Cable Length	51" (129cm)
End Type No.1	D
End Type No.2	E
Part No	GSD113
Price (ea)	£12.16



Outer Cable	Plastic
Cable Length	51" (129cm)
End Type No.1	A
End Type No.2	G
Part No	GSD337
Price (ea)	£11.15



Outer Cable	Plastic
Cable Length	52" (132cm)
End Type No.1	B
End Type No.2	G
Part No	GSD388
Price (ea)	£16.30



Outer Cable	Plastic
Cable Length	54" (137cm)
End Type No.1	D
End Type No.2	G
Part No	GSD273
Price (ea)	£14.56



Outer Cable	Plastic
Cable Length	54" (137cm)
End Type No.1	D
End Type No.2	G
Part No	GSD295
Price (ea)	£15.10



Outer Cable	Plastic
Cable Length	57" (144cm)
End Type No.1	A
End Type No.2	D
Part No	156316
Price (ea)	£14.95



Outer Cable	Plastic
Cable Length	58" (147cm)
End Type No.1	D
End Type No.2	E
Part No	GSD115
Price (ea)	£8.15



Outer Cable	Plastic
Cable Length	60" (152cm)
End Type No.1	D
End Type No.2	E
Part No	GSD117
Price (ea)	£8.40



Outer Cable	Plastic
Cable Length	63" (163cm)
End Type No.1	A
End Type No.2	D
Part No	156318
Price (ea)	£15.46



Outer Cable	Plastic
Cable Length	63" (163cm)
End Type No.1	D
End Type No.2	E
Part No	GSD109
Price (ea)	£8.75



Outer Cable	Plastic
Cable Length	63" (163cm)
End Type No.1	A
End Type No.2	G
Part No	GSD338
Price (ea)	£11.70



Outer Cable	Plastic
Cable Length	66" (167cm)
End Type No.1	D
End Type No.2	E
Part No	GSD114
Price (ea)	£8.10



Outer Cable	Metal
Cable Length	68" (172cm)
End Type No.1	C
End Type No.2	F
Part No	331-135
Price (ea)	£51.00



Outer Cable	Metal
Cable Length	68" (172cm)
End Type No.1	C
End Type No.2	F
Part No	331-140
Price (ea)	£39.95



Outer Cable	Plastic
Cable Length	69" (175cm)
End Type No.1	D
End Type No.2	E
Part No	GSD169
Price (ea)	£14.40



Outer Cable	Plastic
Cable Length	75" (190cm)
End Type No.1	E
End Type No.2	G
Part No	AAU3499
Price (ea)	£13.94



Outer Cable	Metal
Cable Length	78" (198cm)
End Type No.1	C
End Type No.2	F
Part No	331-150
Price (ea)	£49.96



Outer Cable	Plastic
Cable Length	78" (198cm)
End Type No.1	E
End Type No.2	G
Part No	GSD288
Price (ea)	£9.70



Outer Cable	Plastic
Cable Length	81" (205cm)
End Type No.1	D
End Type No.2	E
Part No	504611
Price (ea)	£15.50



Outer Cable	Plastic
Cable Length	96" (243cm)
End Type No.1	D
End Type No.2	E
Part No	504609
Price (ea)	£14.35

Plain Cables - KNOB-LESS CONTROL CABLES



Plain Cables

These cables are supplied with plain ends, allowing you to add your own fittings (see control cable fittings for options). Therefore enabling you to create a bespoke control cable.



Cable Style	Single
Outer Cable	Metal
Inner Cable (Strands)	Solid
Outer Cable Length	34" (86cm)
Inner Cable Length	38" (96cm)
Part No	BHH679
Price (ea)	£3.55

Cable Style	Single
Outer Cable	Metal
Inner Cable (Strands)	Solid
Outer Cable Length	42" (106cm)
Inner Cable Length	46" (116cm)
Part No	BHH678
Price (ea)	£5.95



Cable Style	Single
Outer Cable	Plastic
Inner Cable (Strands)	Solid
Outer Cable Length	34" (86cm)
Inner Cable Length	38" (96cm)
Part No	BHA5407
Price (ea)	£2.65



Slow Running Cable

This cable uses a screw mechanism on the knob to control the pull or push of the inner cable. return spring is also used. Use a solid inner cable for push/pull controls.

Cable Style	Single
Outer Cable	Metal
Inner Cable (Strands)	Solid
Outer Cable Length	55 1/2" (141cm)
Inner Cable Length	62" (157.5cm)
Knob	V
Panel Hole Diameter	1/2" (12.5mm)
Part No	MM331-390
Price (ea)	£49.96

Cable Fittings - CONTROL CABLE FITTINGS



Trunnion Type	Screw (A)
Operating Cable	Inner
Diameter	3/16"
Length	1/4"
Part No	24G1482K
Price (ea)	£1.96



Trunnion Type	Screw (B)
Operating Cable	Inner
Diameter	1/4"
Length	5/16"
Part No	AUE34
Price (ea)	£1.96



Trunnion Type	Pin & Nut (C)
Operating Cable	Inner
Diameter	3/16"
Length	1/2"
Part No	ACC5062K
Price (ea)	£2.15



Trunnion Type	Pin & Sleeve (D)
Operating Cable	Outer
Diameter	3/16"
Length	9/16"
Part No	AHH6734
Price (ea)	£8.45

Heater Cables - HEATER OPERATING CABLES



Cable Style	Single
Outer Cable	Metal
Inner Cable (Strands)	Solid
Outer Cable Length	25" (63cm)
Inner Cable Length	26" (66cm)
Knob	Q
Panel Hole Diameter	3/8" (10mm)
Part No	ACA8211
Price (ea)	£20.80



Cable Style	Single
Outer Cable	Metal
Inner Cable (Strands)	Solid
Outer Cable Length	64" (162cm)
Inner Cable Length	84" (213cm)
Knob	P
Panel Hole Diameter	1/2" (12.5mm)
Part No	611284
Price (ea)	£21.95



Cable Style	Single
Outer Cable	Metal
Inner Cable (Strands)	Solid
Outer Cable Length	25" (63cm)
Inner Cable Length	32" (81cm)
Knob	P
Panel Hole Diameter	1/2" (12.5mm)
Part No	612262
Price (ea)	£19.96



Cable Style	Single
Outer Cable	Metal
Inner Cable (Strands)	Solid
Outer Cable Length	28" (71cm)
Inner Cable Length	32" (81cm)
Knob	P
Panel Hole Diameter	1/2" (12.5mm)
Part No	622361
Price (ea)	£14.40



Cable Style	Single
Outer Cable	Metal
Inner Cable (Strands)	Solid
Outer Cable Length	32" (81cm)
Inner Cable Length	35" (88cm)
Knob	T
Panel Hole Diameter	3/8" (10mm)
Part No	14A9988
Price (ea)	£24.54



Cable Style	Single
Outer Cable	Metal
Inner Cable (Strands)	Solid
Outer Cable Length	9" (99cm)
Inner Cable Length	12" (30cm)
Knob	P
Panel Hole Diameter	1/2" (12.5mm)
Part No	622362
Price (ea)	£11.20



Cable Style	Single
Outer Cable	Plastic
Inner Cable (Strands)	Multi
Outer Cable Length	29" (73cm)
Inner Cable Length	31" (78cm)
Knob	S
Panel Hole Diameter	3/8" (10mm)
Part No	MCR102
Price (ea)	£15.90



Cable Style	Single
Outer Cable	Plastic
Inner Cable (Strands)	Solid
Outer Cable Length	26" (66cm)
Inner Cable Length	29" (73cm)
Knob	R
Panel Hole Diameter	3/8" (10mm)
Part No	MCR101
Price (ea)	£13.50



Cable Style	Single
Outer Cable	Plastic
Inner Cable (Strands)	Solid
Outer Cable Length	29" (73cm)
Inner Cable Length	31" (78cm)
Knob	S
Panel Hole Diameter	3/8" (10mm)
Part No	MCR103
Price (ea)	£15.90



Cable Style	Single
Outer Cable	Plastic
Inner Cable (Strands)	Solid
Outer Cable Length	40" (101cm)
Inner Cable Length	41" (104cm)
Knob	R
Panel Hole Diameter	3/8" (10mm)
Part No	JFF10051
Price (ea)	£15.95



...designed for serious cooling



OEM QUALITY FANS

Revotec OEM quality fan assemblies are designed for serious cooling. Available in various diameters from 167 to 385mm or as part of a bespoke kit, designed for specific models. These fans are a great way to control the temperature of your car's engine.

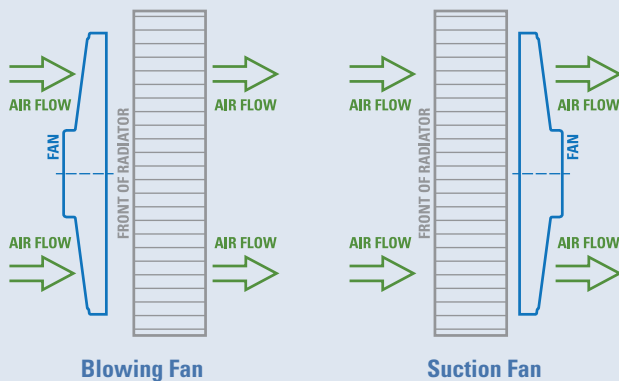

- High performance
- OEM quality
- Full bearing motors
- Low noise
- Light weight
- Versatile installation
- Low profile
- Finger guard

FAN ASSEMBLIES

Keeping your engine running at optimum temperature will ensure you get the best performance and economy. Revotec fan assemblies are designed to run continuously with no loss of performance or reliability. The high quality motor features bearings rather than bushes; the cases are fully waterproof with finger guards for safety.

UNIVERSAL FANS

Available in a choice of either suction (mounted behind radiator) or blowing (mounted in front of radiator), with a range of fan sizes, and either a slim-line or high power motor specification. The fans can be mounted in a variety of ways. Universal brackets are available to suit the various fan sizes and can be adapted to suit the application. We recommend installing the fan with a Revotec electronic temperature controller.

BESPOKE FAN KITS

Revotec and Moss Europe have co-designed high quality bespoke fan kits for Classic Mini, MG, Triumph and Morris Minor models. Designed specifically to fit each model fitting is quick and straight forward with no permanent modifications.

Using the latest high efficiency fans with adjustable electronic controllers these kits are designed to replace the standard original mechanical fan, reducing the load on the engine, noise and improving both power and mpg.

Unlike other fan kits that use a universal mounting system, these Revotec kits have bespoke laser cut brackets that mount directly to the radiator mountings. The brackets are bright passivated to give a smart appearance and prevent corrosion. The kits also use a precise electronic controller to enable easy adjustment to suit your car.



The model kits include:

- High efficiency fan assembly
- Electronic controller with special top hose
- Bespoke passivated brackets for corrosion resistance
- Hardware & wiring Fitting instructions



DESIGNED FOR SERIOUS COOLING

Revotec OEM quality fan assemblies are designed for serious cooling. Available in various diameters from 167 to 385mm. These fans are a great way to control the temperature of your car's engine.

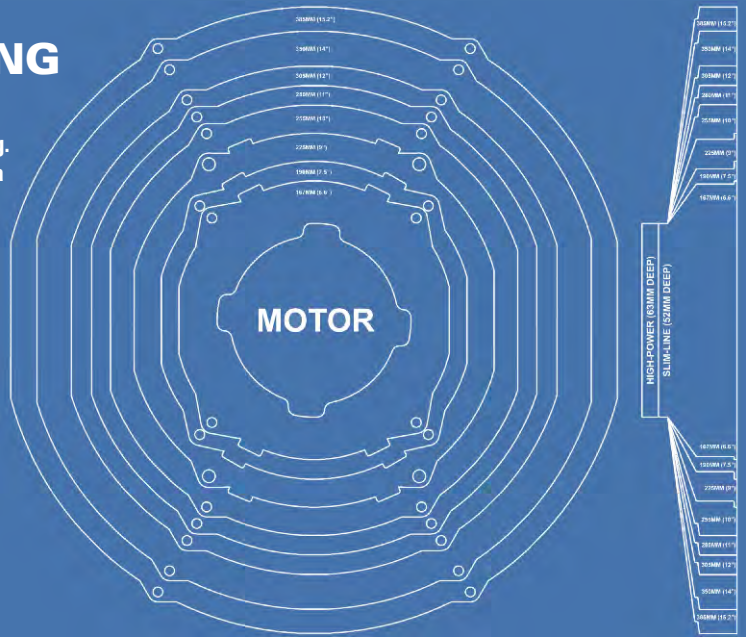

- High performance • OEM quality • Full bearing motors
- Low noise • Light weight • Versatile installation
- Low profile (high power = 63mm) • Finger guard

Electric Fan Components - REVOTEC COOLING FAN COMPONENTS

Fan Assemblies (1)

Revotec OEM quality fan assemblies are designed to run continuously with no loss of performance or reliability. Ideal if you are building a kit car, special or competition car, the high quality motor features bearings rather than bushes; the cases are fully waterproof with finger guards for safety.

Available in a choice of either suction (mounted behind radiator) or blowing (mounted in front of radiator), with a range of fan sizes, and either a slim-line or high power motor specification. The fans can be mounted in a variety of ways. Universal brackets are available to suit the various fan sizes and can be adapted to suit the application. We recommend installing the fan with a Revotec electronic temperature controller.

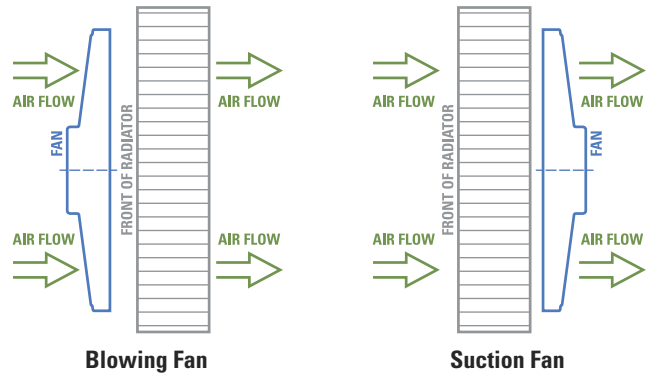













Slimline Fan Assemblies



ID No.	Fan Type	Diameter	Depth	Part No	Price
	Blowing	167mm	52mm	RFA1167B	£57.60
	Blowing	190mm	52mm	RFA1190B	£67.96
	Blowing	225mm	52mm	RFA1225B	£69.95
	Blowing	255mm	52mm	RFA1255B	£71.95
	Blowing	280mm	52mm	RFA1280B	£78.95
2	Blowing	305mm	52mm	RFA1305B	£82.96
	Suction	167mm	52mm	RFA1167S	£58.40
1	Suction	190mm	52mm	RFA1190S	£67.96
	Suction	225mm	52mm	RFA1225S	£69.95
	Suction	255mm	52mm	RFA1255S	£71.95
	Suction	280mm	52mm	RFA1280S	£78.95
	Suction	305mm	52mm	RFA1305S	£82.96

High Power Fan Assemblies

ID No.	Fan Type	Diameter	Depth	Part No	Price
3	Blowing	255mm	63mm	RFA2255B	£82.96
	Blowing	280mm	63mm	RFA2280B	£87.95
	Blowing	305mm	63mm	RFA2305B	£89.95
	Blowing	350mm	63mm	RFA2350B	£91.96
	Blowing	385mm	63mm	RFA2385B	£106.96
	Suction	255mm	63mm	RFA2255S	£82.96
4	Suction	280mm	63mm	RFA2280S	£87.95
	Suction	305mm	63mm	RFA2305S	£89.95
	Suction	350mm	63mm	RFA2350S	£91.96
	Suction	385mm	63mm	RFA2385S	£106.96

					
To Suit Fan Diameter 190mm	Part No RFB190	Price £14.40	To Suit Fan Diameter 225mm	Part No RFB225	Price £14.40
To Suit Fan Diameter 255mm	Part No RFB255	Price £14.40	To Suit Fan Diameter 280mm	Part No RFB280	Price £14.40

					
To Suit Fan Diameter 280mm	Part No RFB280	Price £14.40	To Suit Fan Diameter 305mm	Part No RFB305	Price £14.40
To Suit Fan Diameter 350mm	Part No RFB350	Price £14.40			

	
To Suit Fan Diameter 1385mm	Part No RFB385
Price £14.40	

Fan Mounting Brackets (2a)
Brackets for mounting Revotec cooling fans. Can be modified to suit most applications.

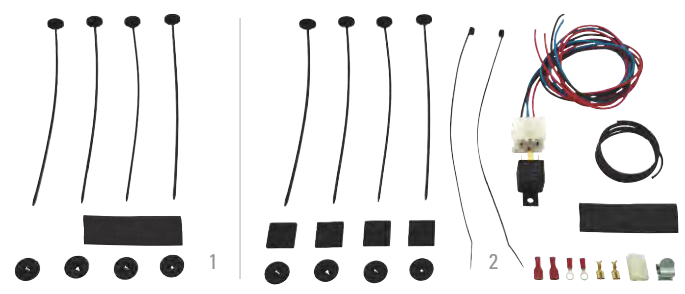

Pull-Through Fan Mountings (2b)
Special pull through fan fittings designed to hold the fan against the radiator core.

ID No.	Description	Part No	Price
1	Pull-Through Fitting Kit	RFK001	£5.75
2	Pull-Through Fitting & Wiring Kit	RFK002	£17.95

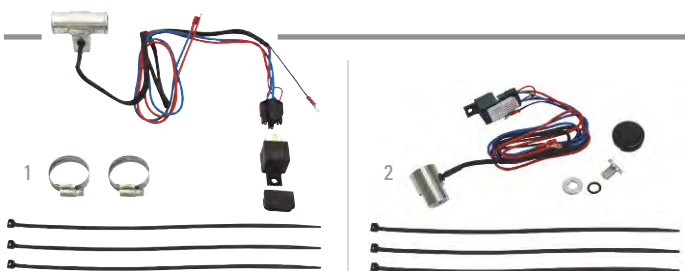

Electronic Fan Controllers (3)
These simple fan controllers allow you to control the temperature at which the Revotec fan cuts in and out, available in a range of fittings.

Hose Fitting Fan Controllers (3a)
Designed to fit in the coolant hose (hose will require cutting).

ID No.	Hose ID	Part No	Price
1	25mm	RFC001	£65.95
	28mm	RFC002	£68.95
	32mm	RFC003	£68.95
	35mm	RFC004	£68.95
	38mm	RFC005	£68.95

Designed to be fitted through a hole in to wall of the hose.

ID No.	Description	Part No	Price
2	Self Sealing	RFC011	£80.95

Revotec
DRIVEN BY SUCCESS

3 Steps To Building A Bespoke Revotec Cooling Fan Kit

(1) Cooling Fan

Select the fan type - blowing or suction and size (167-385mm diameter).

(2) Mounting Kit

Select the mounting bracket, alternatively if a suitable bracket is not available use a pull-through mounting.

(3) Electronic Controller

Finally, select the fan controller, located either in the coolant hose or directly into the radiator.

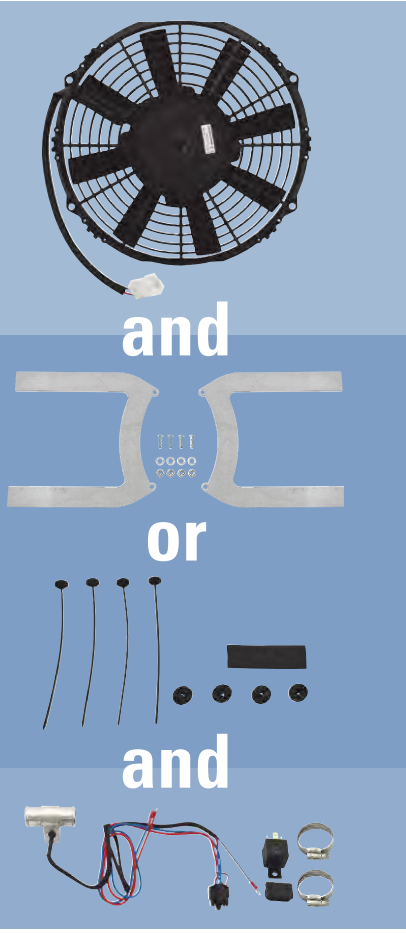

Threaded Fitting Fan Controllers (3b)
Designed to fit into M22 x 1.5 threaded bosses in radiators or coolant pipes. Bosses also available.

ID No.	Description	Material	Part No	Price
1	M22 x 1.5		RFC010	£68.95
2	Boss M22 x 1.5	Brass	RFC012	£9.60
3	Boss M22 x 1.5	Aluminium	RFC013	£9.60
4	Plug M22 x 1.5	Brass	RFC014	£9.60
5	Plug M22 x 1.5	Aluminium	RFC015	£9.60

Stainless coolant pipe with M22 x 1.5 boss.

ID No.	Description	O/D	Length	Part No	Price
	Stainless Steel	1 1/4"	16"	158417SST	£31.96

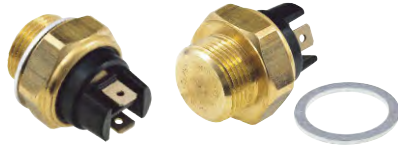

IM50090

Thermostatic Fan Switches

Simple M22 x 1.5 threaded thermal switches suitable for controlling cooling fans.

Description	Temperature Range	Thread	Part No	Price
Fan Switch	On 88° - Off 79°	M22 x 1.5	IM50090	£8.95
Fan Switch	On 82° - Off 68°	M22 x 1.5	IM50100	£10.96
Fan Switch	On 92° - Off 87°	M22 x 1.5	IM50200	£7.96
Fan Switch	On 88° - Off 74°	M22 x 1.5	IM50250	£8.95

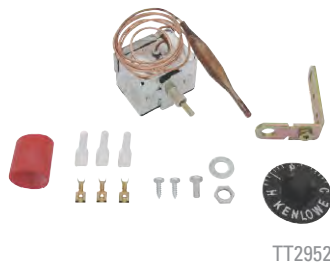

TT2952

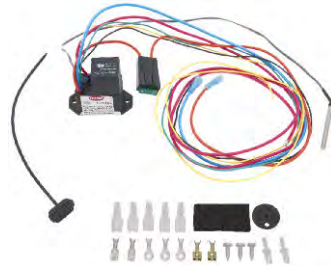

TT29521



TT2948



TT2947X

Kenlowe Thermostatic Fan Controllers

A fan controller allows you to control the temperature at which the cooling fan cuts in and out. Kenlowe also offers a manual override switch that allows you to adjust and operate the fan separately to the fan controller.

Description	Type	Part No	Price
Fan Controller, Adjustable	Capillary	TT2952	£53.95
Fan Controller, Adjustable	Electronic	TT29521	£47.95
Fan Controller, Manual Override		TT2948	£10.80
Seal, for Fan Controller	Capillary	TT2947X	£1.80

Drive Belts - FAN BELTS



GCB11125

GFB40975

Fan Belts

An essential component to aid the smooth running of components, worn or incorrectly adjusted belts not only result in poor cooling but can also cause premature wear in alternator and dynamo bearings.

Width	Length	Part No	Price	Width	Length	Part No	Price
10mm	750mm	GCB10750	£2.65	10mm	1088mm	GCB11088	£4.96
10mm	788mm	GCB10788	£4.96	10mm	1100mm	GCB11100	£7.75
10mm	800mm	GCB10800	£7.60	10mm	1125mm	GCB11125	£5.20
10mm	813mm	GCB10813	£3.50	10mm	1150mm	GCB11150	£6.76
10mm	825mm	GCB10825	£4.25	13mm	610mm	GCB20610	£3.32
10mm	838mm	GCB10838	£3.95	13mm	762mm	GCB20762	£0.26
10mm	850mm	GCB10850	£8.60	13mm	897mm	GCB20897	£5.30
10mm	863mm	GCB10863	£6.16	13mm	990mm	GCB20990	£3.67
10mm	887mm	GCB10887	£8.95	13mm	1025mm	GCB21075	£6.35
10mm	900mm	GCB10900	£4.15	13mm	1160mm	GCB21160	£9.25
10mm	925mm	GCB10925	£9.40	13mm	1175mm	GCB21175	£1.39
10mm	950mm	GCB10950	£6.55	15mm	990mm	434-125	£26.95
10mm	963mm	GCB10963	£7.20	19.5mm	975mm	GFB40975	£16.96
10mm	975mm	GCB10975	£7.30				
10mm	1025mm	GCB11025	£7.45				
10mm	1038mm	GCB11038	£5.95				
10mm	1050mm	GCB11050	£7.75				

Exhaust - EXHAUST CLAMPS



U Bolt Clamps

Description	Size	Material	Qty.	Part No	Price
U Bolt Clamp	1 1/8" (29 mm)	Steel	1	GEX9001	£0.25
U Bolt Clamp	1 1/4" (32 mm)	Steel	1	GEX9002	£0.65
U Bolt Clamp	1 3/8" (35 mm)	Steel	1	GEX9003	£0.65
U Bolt Clamp	1 1/2" (38 mm)	Steel	1	GEX9004	£0.95
U Bolt Clamp	1 5/8" (41 mm)	Steel	1	GEX9005	£0.95
U Bolt Clamp	1 3/4" (44 mm)	Steel	1	GEX9007	£0.70
U Bolt Clamp	1 7/8" (47 mm)	Steel	1	GEX9008	£0.70
U Bolt Clamp	2" (50 mm)	Steel	1	GEX9009	£0.90
U Bolt Clamp	2 1/8" (54 mm)	Steel	1	GEX9010	£0.74
U Bolt Clamp	2 1/4" (57 mm)	Steel	1	GEX9011	£0.95
U Bolt Clamp	2 3/8" (60 mm)	Steel	1	GEX9012	£1.00
U Bolt Clamp	2 1/2" (63 mm)	Steel	1	GEX9013	£1.10

Mikalor Clamps

Mikalor stainless steel band clamps are manufactured to the highest standards and are the best clamps available, ideal for motor sport applications.



Description	Size	Material	Qty.	Part No	Price
Mikalor Clamp	1 7/16" to 1 9/16" (37-40 mm)	S/Steel	1	TT9930S	£2.26
Mikalor Clamp	1 9/16" to 1 11/16" (40-43 mm)	S/Steel	1	TT9931S	£2.45
Mikalor Clamp	1 11/16" to 1 7/8" (43-47 mm)	S/Steel	1	TT9932S	£2.95
Mikalor Clamp	1 7/8" to 2" (47-51 mm)	S/Steel	1	TT9933S	£2.45
Mikalor Clamp	2" to 2 5/32" (51-55 mm)	S/Steel	1	TT9934S	£2.45
Mikalor Clamp	2 5/32" to 2 5/16" (55-59 mm)	S/Steel	1	TT9936S	£2.65
Mikalor Clamp	2 5/16" to 2 1/2" (59-63 mm)	S/Steel	1	TT9937S	£2.75
Mikalor Clamp	2 1/2" to 2 11/16" (63-68 mm)	S/Steel	1	TT9938S	£2.84

Exhaust - EXHAUST SLEEVES & ADAPTORS

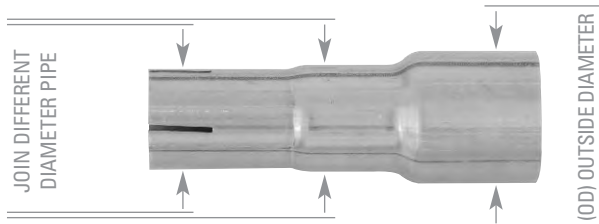

Stepped Exhaust Adaptor

Stepped adaptors allow you to join various diameter exhaust pipes together without the inconvenience of manufacturing specialist joints or flaring pipe ends. Simply cut and install the existing system or adaptor where appropriate. Double stepped adaptors can be cut to suit alternative configurations.

Description	Size (OD)	Length	Material	Part No	Price
Sleeve	1 3/4"	6"	S/Steel	TT5911S	£13.96
Sleeve	1 3/4"	14"	S/Steel	BST018	£15.60
Sleeve	1 5/8"	6"	S/Steel	TT5918	£6.10
Sleeve	1 7/8"	14"	S/Steel	BST019	£10.36
Sleeve	2"	14"	S/Steel	BST015	£22.90

S/Adaptor, single	1 7/8" x 2"	14"	S/Steel	BST014	£31.25
S/Adaptor, single	1 3/4" x 1 7/8"	4"	S/Steel	TT5913SS	£12.20
S/Adaptor, double	1 1/2" x 1 5/8" x 1 7/8"	6"	S/Steel	TT5917	£12.95
S/Adaptor, double	1 1/2" x 1 5/8" x 2"	6"	S/Steel	PME43X	£17.15



Heat Insulation Products - INSULATION PRODUCTS

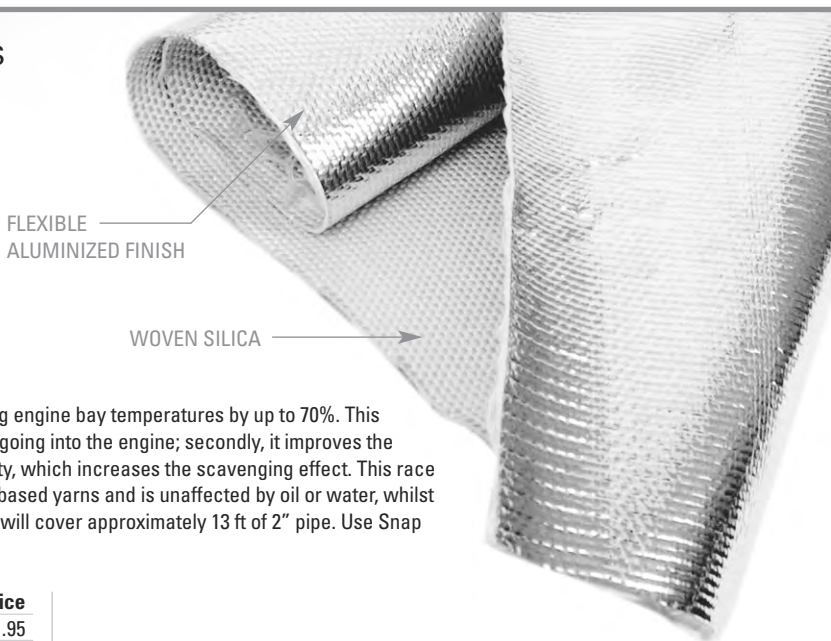
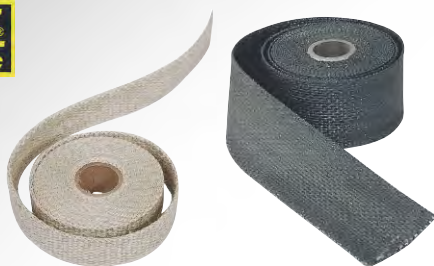
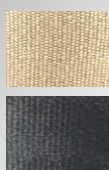

Thermo-Tec Exhaust Wrap

Wrapping a tubular manifold will keep engine bay heat to a minimum, reducing engine bay temperatures by up to 70%. This will benefit power in two ways; firstly it will reduce the temperature of the air going into the engine; secondly, it improves the effectiveness of the manifold by increasing gas speed due to lower gas density, which increases the scavenging effect. This race proven, asbestos free, product from Thermo-Tec is manufactured from Silica based yarns and is unaffected by oil or water, whilst withstand temperatures of up to 1000°C. As a guide to coverage a 2" x 50' roll will cover approximately 13 ft of 2" pipe. Use Snap Straps to hold the wrap in position.

Description	Length	Width	Colour	Part No	Price
Thermo-Tec Wrap	15' (4.57 m)	1"	Natural	GAC150	£11.95
Thermo-Tec Wrap	15' (4.57 m)	1"	Black	GAC151	£13.94
Thermo-Tec Wrap	15' (4.57 m)	2"	Natural	GAC152	£19.94
Thermo-Tec Wrap	15' (4.57 m)	2"	Black	GAC153	£21.95
Thermo-Tec Wrap	50' (15.24 m)	1"	Natural	GAC154	£34.96
Thermo-Tec Wrap	50' (15.24 m)	1"	Black	GAC155	£38.95
Thermo-Tec Wrap	50' (15.24 m)	2"	Natural	GAC156	£58.96
Thermo-Tec Wrap	50' (15.24 m)	2"	Black	GAC157	£64.96

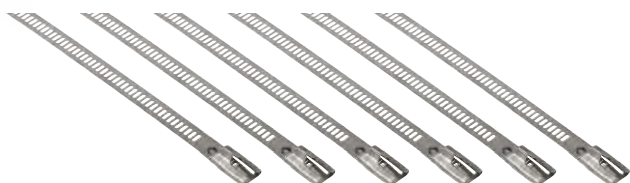

Snap Straps

Description	Qty x Length	Qty x Length	Material	Part No	Price
Snap Strap Set	8 x 9" (228 mm)	4 x 18" (457 mm)	S/Steel	GAC172	£31.94
Snap Strap Set	6 x 9" (228 mm)	4 x 18" (457 mm)	S/Steel	GAC173	£27.95
Snap Strap Set	12 x 9" (228 mm)		S/Steel	GAC174	£29.95
Snap Strap Set	6 x 18" (457 mm)		S/Steel	GAC175	£19.94
Snap Strap Set	4 x 14" (355 mm)		S/Steel	GAC176	£9.95



Thermo-Tec Insulation Blanket

Using a manifold blanket provides excellent heat retention, easily installed to both cast iron and tubular manifold. The manifold should be wrapped first then the blanket can be fitted over the wrapping and retained with Snap Straps.

Description	Size	Part No	Price
4-6 Cylinder Inline Engine	36" x 40" (914 x 1016 mm)	GAC182	£99.95
V6 or V8 Engine	20" x 24" (508 x 610 mm)	GAC183	£108.95
Catalyst or Silencer	40" x 24" (1016 x 610 mm)	GAC184	£78.95
Heat Mat	39" x 39" (990 x 990 mm)	GAC185	£71.95

Headlamp - HEADLAMP RIMS

Headlamp Rims

As well as improving the appearance of the headlamps they also hide, retain and protect the lamp fittings.



Description	Headlamp Rim
Lamp Diameter	7"
Profile	Flat
Clip/Screw	Screw
Finish	Chrome
Quantity	1
Part No	142001
Price (ea)	£14.70



Description	Headlamp Rim
Lamp Diameter	7"
Profile	Flat
Clip/Screw	Clip
Finish	Chrome
Quantity	1
Part No	57H5296
Price (ea)	£14.10



Description	Headlamp Rim
Lamp Diameter	7"
Profile	Curved
Clip/Screw	Screw
Finish	Chrome
Quantity	1
Part No	500929
Price (ea)	£12.95



Description	Headlamp Rim
Lamp Diameter	7"
Profile	Curved
Clip/Screw	Clip
Finish	Chrome
Quantity	1
Part No	57H5455
Price (ea)	£15.95



Description	H/Rim Lightweight
Lamp Diameter	7"
Profile	Curved
Clip/Screw	Clip
Finish	Alloy
Quantity	1
Part No	500929ALLOY
Price (ea)	£20.95

Headlamp Rim Accessories

Description	Qty.	Part No	Price
Spring Clip	1	BAU1460	£1.66

Description	Qty.	Part No	Price
Screw-On Clip	1	37H7421A	£2.86

Description	Qty.	Part No	Price
Screw	1	RTC465	£0.50

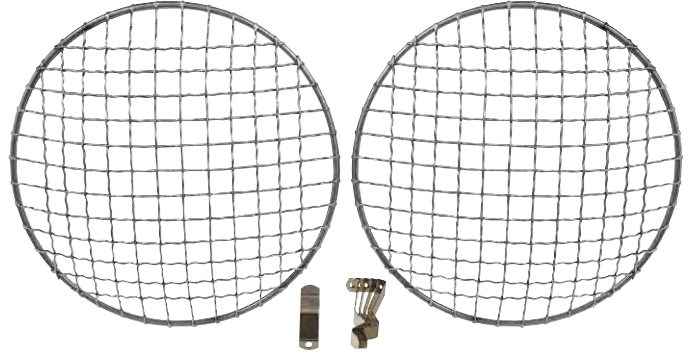

Headlamp Stoneguards
Protect the headlamps with these period styled chrome headlamp guards.

Description	Stoneguards, Mesh
Lamp Diameter	7"
Fitting Type	Clip
Finish	Chrome
Quantity	Pair
Part No	GAC8000X
Price (ea)	£9.95

Bonnet Fasteners - BONNET STRAPS & PINS



Bonnet Straps & Pin Set

Supplied in a selection of styles and materials, suitable for bespoke conversions or motor sport applications. Can be used for bonnets and boot lids or any similar application.

Bonnet Straps, Rubber

Description	Material	Colour	Qty.	Part No	Price
Rubber Hook	Rubber	Black	Pair	HMP190136	£9.80

Bonnet Pins

Description	Material	Colour	Qty.	Part No	Price
Pin Set	S/Steel	Silver	Pair	MRAC801S	£16.00

Leather Bonnet Straps, Works Style

Description	Material	Colour	Qty.	Part No	Price
Buckle Strap	Leather	Black	Single	222-601	£13.94
Buckle Strap	Leather	Black	Pair	222-602	£25.96
Buckle Strap	Leather	Tan	Single	222-729	£13.94
Buckle Strap	Leather	Tan	Pair	222-728	£25.96

Number Plates - NUMBER PLATE FIXINGS

Number Plate Backing Plates

We offer a wide range of number plate backing plates. These are suitable for standard UK oblong or rectangular number plates. Bumper mount types are plain backing plates, body mount types feature brackets to fit a buffer to prevent damage to car paint & bodywork.



ID No.	Shape	Type	Mounting Location	Material	Finish	Lamp Mounting	Body Buffer Bracket	Size	Part No	Price
1	Oblong	Universal	Bumper	Steel	Black	No	No	20 1/2" x 4 1/2" (520mm x 115mm)	ALK3268	£3.83
2	Oblong	Universal	Bumper	S/Steel	Bright	No	No	20 1/2" x 4 1/2" (520mm x 115mm)	ALK3268SS	£8.15
3	Oblong	Universal	Bumper	Steel	Black	No	No	20 1/2" x 4 1/2" (520mm x 115mm)	BHH1524	£3.83
4	Oblong	Universal	Bumper	S/Steel	Bright	No	No	20 1/2" x 4 1/2" (520mm x 115mm)	BHH1524SS	£13.10
5	Oblong	Universal	Body	Steel	Black	No	Yes*	20 1/2" x 4 1/2" (520mm x 115mm)	AHA5791	£3.83
6	Oblong	Universal	Body	S/Steel	Bright	No	Yes*	20 1/2" x 4 1/2" (520mm x 115mm)	AHA5791SS	£15.90
7	Oblong	Rear	Body	Steel	Black	Yes	Yes*	25 1/2" x 4 1/2" (650mm x 115mm)	BHH1673	£3.83
8	Oblong	Rear	Body	S/Steel	Bright	Yes**	Yes*	25 1/2" x 4 1/2" (650mm x 115mm)	BHH1673SS	£15.95
9	Oblong	Rear	Bumper	Steel	Black	Yes**	No	25 1/2" x 4 1/2" (650mm x 115mm)	14A7552Z	£8.95
10	Oblong	Rear	Bumper	S/Steel	Bright	Yes**	No	25 1/2" x 4 1/2" (650mm x 115mm)	14A7552SS	£20.40
11	Rectangular	Universal	Universal	Steel	Black	No	No	12" x 6" (305mm x 52mm)	AHA5211	£7.15
12	Rectangular	Universal	Universal	S/Steel	Bright	No	No	12" x 6" (305mm x 52mm)	AHA5211SS	£24.46
13	*Buffer, 2 reqd per backing		N/A	N/A	N/A	N/A	N/A	N/A	AHA5804	£1.15

** Use Lucas 467 type number plate lamp, see page 61

Number Plate Surround

Fits all standard UK type oblong number plates, front or rear.

Description	Material	Finish	Part No	Price
No. Plate Surround	Plastic	Chrome	GAC0070	£11.15

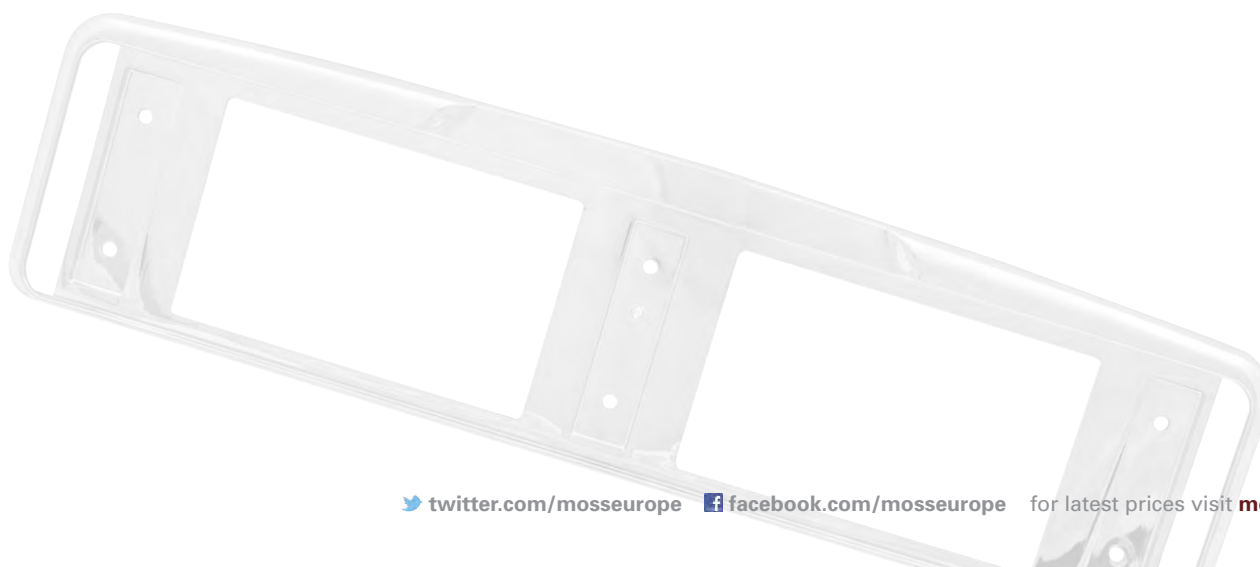

Badges, Decals & Stickers - GRILLE & BAR BADGES



Description BMC Drivers Club

Fitting Grille/Bar
Finish Chrome/Enamel
Part No GAC9967X
Price (ea) £77.95



Description British Motor Racing Marshalls Club

Fitting Grille/Bar
Finish Chrome/Enamel
Part No GAC9987X
Price (ea) £70.96



Description British Racing & Sports Car Club

Fitting Grille/Bar
Finish Chrome/Enamel
Part No GAC9969X
Price (ea) £22.75



Description Brooklands BARC

Fitting Grille/Bar
Finish Chrome/Enamel
Part No GAC9966X
Price (ea) £22.75



Description Festival of Britain

Fitting Grille/Bar
Finish Chrome/Enamel
Part No GAC9985X
Price (ea) £69.95



Description England Union Flag (Toothed)

Fitting Grille/Bar
Finish Chrome/Enamel
Part No GAC8043X
Price (ea) £28.96



Description Queen Elizabeth Commonwealth

Fitting Grille/Bar
Finish Chrome/Enamel
Part No GAC9968X
Price (ea) £93.95



Description Coat of Arms

Fitting Grille/Bar
Finish Chrome/Enamel
Part No GAC9965X
Price (ea) £69.95



Description St. Christopher

Fitting Grille/Bar
Finish Chrome/Enamel
Part No GAC9970X
Price (ea) £63.95



Description RAC Diamond

Fitting Grille/Bar
Finish Chrome/Enamel
Part No GAC9971X
Price (ea) £75.95



Description RAC Round Laurel

Fitting Grille/Bar
Finish Chrome/Enamel
Part No GAC1028X
Price (ea) £75.95



Description RAC Toothed

Fitting Grille/Bar
Finish Chrome/Enamel
Part No GAC8045X
Price (ea) £28.96



Description Clip, Badge to Badge Bar (3/4")

Fitting N/A
Finish Chrome
Part No GAC8041X
Price (ea) £3.50



Description Fitting Plate, Badge to Grille

Fitting N/A
Finish Metal
Part No GAC8042X
Price (ea) £4.55

Badges, Decals & Stickers - ADHESIVE & BOLT-ON BADGES



Description	UK Map Shape
Fitting	Self Adhesive
Material	Metal
Finish	Polished
H x W	100 x 64mm
Quantity	1
Part No	105-432
Price (ea)	£8.12



Description	Supercharged
Fitting	Self Adhesive
Material	Plastic
Finish	Chrome
H x W	10 x 135mm
Quantity	1
Part No	648-210
Price (ea)	£14.95



Description	Union Jack
Fitting	Self Adhesive
Material	Plastic
Finish	N/A
H x W	47 x 78mm
Quantity	2
Part No	CRST186
Price (ea)	£3.95



Description	U/Jack/Chequered Flag
Fitting	Self Adhesive
Material	Plastic
Finish	N/A
H x W	27 x 46mm
Quantity	1
Part No	DAG000070MMM
Price (ea)	£31.94



Description	Union Jack
Fitting	Self Adhesive
Material	Plastic
Finish	N/A
H x W	24 x 42mm
Quantity	1
Part No	DAG000080MMM
Price (ea)	£19.96



Description	Union Jack
Fitting	Self Adhesive
Material	Chrome
Finish	Chrome
H x W	100 x 50mm
Quantity	1
Part No	GAC4100CR
Price (ea)	£9.16



Description	GB, 3 Piece Set
Fitting	Self Adhesive
Material	Plastic
Finish	Chrome
H x W	65 x 100mm
Quantity	1
Part No	MRD1034A
Price (ea)	£10.15



Description	GB, 2 Piece Set
Fitting	Self Adhesive
Material	Chrome
Finish	Chrome
H x W	85 x 110mm
Quantity	1
Part No	MRD1034SA
Price (ea)	£12.80



Description	Union Jack
Fitting	Magnetic
Material	Plastic
Finish	Plastic
H x W	75 x 125mm
Quantity	1
Part No	MM215-330
Price (ea)	£9.20



Description	Union Jack
Fitting	Bolt-On
Material	Chrome/Enamel
Finish	N/A
H x W	30 x 50mm
Quantity	1
Part No	GAC4100
Price (ea)	£6.60



Description	Union Jack
Fitting	Bolt-On
Material	Chrome/Enamel
Finish	N/A
H x W	35 x 57mm
Quantity	2
Part No	GAC4101
Price (ea)	£12.95



Screens - SCREENS & VISORS



Description	Aeroscreen, Brooklands
Material	Glass/Aluminium
Length	15 1/2"
Height	6 1/2"

Quantity	1
Part No	700896
Price	£69.95



Description	Wind Wing, Detachable
Material	Plastic/Chrome
Length	13 1/4"
Height	6"

Quantity	Pair
Part No	MM240-200
Price	£54.95



Description	Sun visor, Detachable
Material	Plastic/Chrome
Length	13 3/4"
Height	4"

Quantity	Pair
Part No	MM240-300
Price	£23.50



Boot Racks - BOOT RACKS & ACCESSORIES

Boot Racks

Essential for touring, when your boot isn't big enough. Simple clip-on fittings ensure no holes or permanent modifications need to be made to your car. Available in a range of materials.

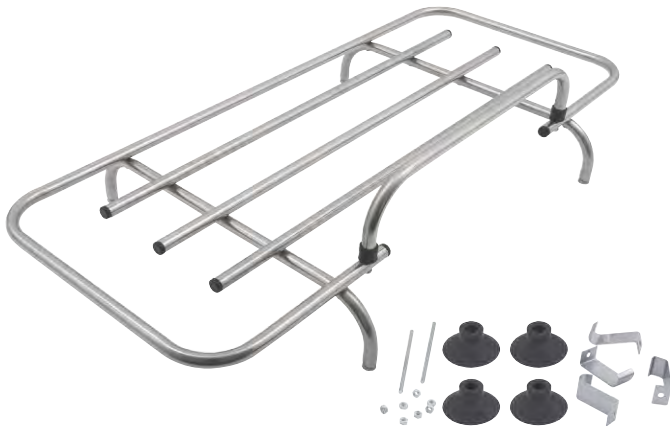

Description	Clip-On, Rack
Material	S/Steel with S/Steel Slats
L x H x W	890 x 100 x 380mm
Quantity	1
Part No	GAC4004SS
Price	£86.95

Description	Clip-On, Rack
Material	Alloy with Alloy Slats
L x H x W	890 x 100 x 380mm
Quantity	1
Part No	GAC4001
Price	£59.95



Description	Clip-On, Rack
Material	S/Steel with Wood Slats
L x H x W	890 x 100 x 380mm
Quantity	1
Part No	GAC4005SS
Price	£91.94

Description	Clip-On, Rack
Material	Alloy with Wood Slats
L x H x W	890 x 100 x 380mm
Quantity	1
Part No	GAC4005X
Price	£64.96

Boot Racks - BOOT RACKS & ACCESSORIES



Spare Boot Rack Fitting Kit

Description	Quantity	Part No	Price
Fitting Kit, Spare	1	BRK1	£20.50

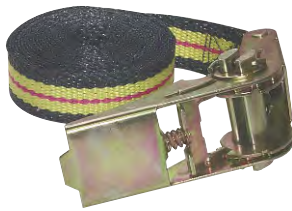

Lashing Ratchet Straps

Length	Quantity	Part No	Price
3.5m	1	CAR10002	£8.87



Length	Quantity	Part No	Price
5m	1	CAR10003	£9.65

Hardtop - HARDTOP STORAGE CADDY

Hardtop Storage Caddy & Cover

This manoeuvrable caddy and cover allows simple and safe storage of a detachable roof or hardtop.

Description	Part No	Price
Caddy & Cover	MXV1120X	£89.95



Extending Wheel Nut Wrench
 Extends from 355-520mm, supplied with 17 x 19mm & 21 x 23mm sockets.
 MTR461102 £10.75

Road Wheels - WHEELS, TYRES & ROADSIDE EQUIPMENT

Wheel Nuts

We recommend using a flat drive socket with these wheel nuts.



Thread	3/8 UNF
Type	Bulge
Socket Size	11/16" 17mm
Seat Type	Cone 60°
Finish	Chrome
Part No	TT6320
Price (ea)	£1.94



Thread	3/8 UNF
Type	Open
Socket Size	11/16" 17mm
Seat Type	Radius
Finish	Plain
Part No	88G322
Price (ea)	£0.65



Thread	3/8 UNF
Type	Bulge
Socket Size	11/16" 17mm
Seat Type	Radius
Finish	Chrome
Part No	GAC8210XNT
Price (ea)	£1.13



Thread	3/8 UNF
Type	Straight
Socket Size	11/16" 17mm
Seat Type	Cone 60°
Finish	Chrome
Part No	AHA8785
Price (ea)	£1.36



Thread	7/16 UNF
Type	Bulge
Socket Size	3/4 19mm
Seat Type	Cone 60°
Finish	Chrome
Part No	GAC8225XMGNUT
Price (ea)	£2.21



Thread	7/16 UNF
Type	Open
Socket Size	3/4 19mm
Seat Type	Radius
Finish	Plain
Part No	88G276
Price (ea)	£1.75



Thread	7/16 UNF
Type	Open
Socket Size	7/8 22mm
Seat Type	Radius
Finish	Plain
Part No	109586
Price (ea)	£2.26



Thread	7/16 UNF
Type	Tube
Socket Size	3/4 19mm
Seat Type	Shoulder
Finish	Chrome
Part No	GAC8225XNT
Price (ea)	£2.40



Thread	1/2 UNF
Type	Bulge
Socket Size	3/4 19mm
Seat Type	Cone 60°
Finish	Chrome
Part No	TMG60720
Price (ea)	£2.56



Thread	1/2 UNF
Type	Open
Socket Size	7/8 22mm
Seat Type	Radius
Finish	Plain
Part No	BTB354
Price (ea)	£1.15



Thread	1/2 UNF
Type	Straight
Socket Size	13/16 21mm
Seat Type	Cone 60°
Finish	Chrome
Part No	AHH9152
Price (ea)	£1.15



Thread	M12 x 1.5
Type	Bulge
Socket Size	3/4 19mm
Seat Type	Cone 60°
Finish	Chrome
Part No	TT6520
Price (ea)	£1.25

Road Wheels - WHEELS, TYRES & ROADSIDE EQUIPMENT



Wire Wheel Tools

ID No.	Description	Spinner Type	Part No	Price
1	Vintage Screw Jack	N/A	AHH5124K	£103.96
2	Copper & Hide Mallet, 1kg	N/A	C27290	£22.94
3	Spoke Adjusting Spanner	N/A	MM385-800	£7.96
4	Short Spanner	Octagon	AHH5839	£5.65

ID No.	Description	Spinner Type	Part No	Price
5	Wooden Spanner	2 Eared	AHH5839W	£20.95
6	Long Spanner	Octagonal	MM386-120	£46.96
7	Long Spanner	2 Eared	MM386-125	£46.96
8	Long Spanner	2 Eared, 52mm	MM386-130	£59.95
9	Wooden Spanner	2 Eared, 52mm	MM386-175	£49.96

Wire Wheel Spinners

High quality chrome plated spinners for use with knock-on type wire wheels.



Octagonal Spinners

Shape/Type	Thread	Hand	Part No	Price
Octagonal	8TPI	LH	88G607	£23.95
Octagonal	8TPI	RH	88G606	£23.95
Octagonal	12TPI	LH	AHH7316	£22.96
Octagonal	12TPI	RH	AHH7315	£22.96



2 Ear Spinners

Shape/Type	Thread	Hand	Part No	Price
2 Ears	8TPI	LH	AHA7374	£23.95
2 Ears	8TPI	RH	AHA7373	£23.95
2 Ears	12TPI	LH	AHH7318	£24.95
2 Ears	12TPI	RH	AHH7317	£24.95



3 Ear Spinners

Shape/Type	Thread	Hand	Part No	Price
3 Ears	8TPI	LH	107949/3	£45.95
3 Ears	8TPI	RH	107948/3	£45.95
3 Ears	12TPI	LH	AHH73183	£45.95
3 Ears	12TPI	RH	AHH73173	£45.95

Wire Wheel Hub Adaptors

Hub adaptors can be used to convert to knock-on wire wheels. They mount to the hub face using existing wheel studs. Care must be taken to select the correct wheel. Special wheel nuts are required to retain the hub adaptors.

ID No.	Thread	Hand	Stud Pattern	Stud Thread	Part No	Price
	8TPI	LH	N/A	7/16 UNF	217603	£30.95
1	8TPI	RH	N/A	7/16 UNF	217602	£30.95
	8TPI	LH	N/A	3/8 UNF	142598	£37.25
2	8TPI	RH	N/A	3/8 UNF	142597	£37.25



Rim Bands

Creating an air tight seal on a wire wheel can be tricky. Use a rim band to prevent the inner tube from chaffing against the spoke nipples.

ID No.	Description	Fitting	Part No	Price
1	Rim Band	13" Wheel	452-730	£9.95
	Rim Band	14" Wheel	452-740	£9.95
	Rim Band	15" Wheel	452-750	£9.95
2	Rim Band	16" Wheel	452-770	£5.24
3	Rim Band	19" Wheel	452-760	£13.96



Inner Tubes

Using the correct size of inner tubes will reduce tube failures and heat build up in the tyre.

ID No.	Description	Quantity	Part No	Price
2	13" x 145/155	1	452-725	£10.94
	14" x 155/165	1	452-735	£14.95
	14" x 175/185	1	452-745	£13.96
3	15" x 155/165	1	452-755	£11.75
	15" x 175/185	1	452-765	£14.95
1	19" x 450, Heavy Duty	1	452-785	£44.95
	19" x 450/500	1	454-410	£14.95
	15" x 550	1	454-420	£29.95

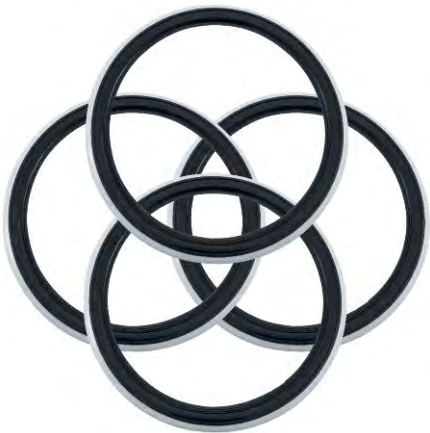

Tyre Trim Set

Description	Colour	Qty.	Part No	Price
13" Trim	White	4	GLZ225WWX4	£51.95
14" Trim	White	4	GLZ226WWX4	£51.95
15" Trim	White	4	GLZ227WWX4	£51.95

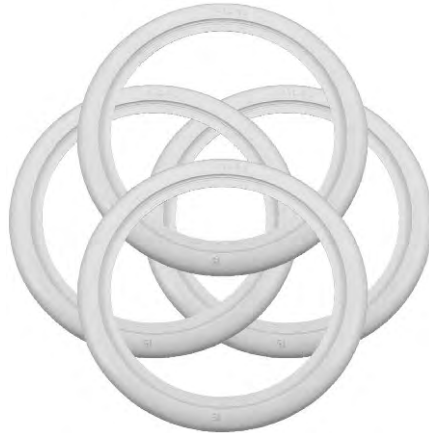

Description	Colour	Qty.	Part No	Price
15" Extra Wide	White	4	GLZ228WWX4	£51.95

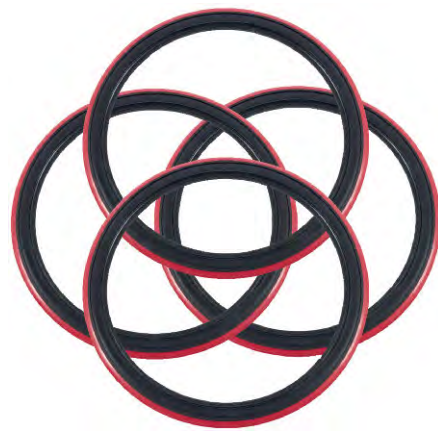

Description	Colour	Qty.	Part No	Price
15" Trim	Red	4	GLZ229RWX4	£51.95

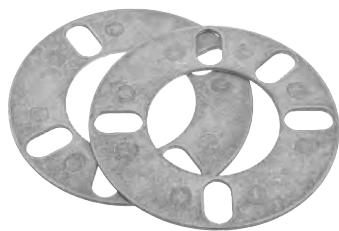

3mm THICKNESS



6mm THICKNESS

Wheel Spacer Set

Adjust the wheel position without the need to extended studs or nuts in most cases. Only one per wheel.

Description	Thickness	Material	Quantity	Part No	Price
4 or 5 Stud Fitting	3mm	Alloy	2	TT6901	£13.94
4 or 5 Stud Fitting	6mm	Alloy	2	TT6902	£17.95

Exterior - MIRRORS

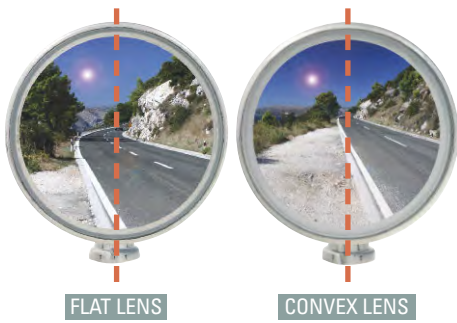

Mirrors

Mirrors can transform the appearance of a car whilst improving rearward vision and safety. One major safety feature is the use of a convex lens, this shows a wider view of whats behind you and can help to catch those objects in your blind spot.

Offered in a vast range of styles and finishes for installation on wings, door and screen frame for permanent or clamp-on fitting.

Raydot Style Racing Mirrors



Description	Raydot Style
Mounting	Universal
Head Shape	Round
Finish	Brushed Satin/Black Pedestal Alloy
Head Dia.	4" (100mm)
Lens Type	Flat
RH/LH	Universal
Mount Type	Stud/Internal
Bolt Dia.	1/16"
Fixing Centres	N/A
Part No	222-355
Price	£22.96



Description	Raydot Style
Mounting	Universal
Head Shape	Round
Finish	Polished Alloy
Head Dia.	4" (100mm)
Lens Type	Flat
RH/LH	Universal
Mount Type	Stud/Internal
Bolt Dia.	1/2"
Fixing Centres	N/A
Part No	MT9314
Price	£22.96

Bullet Style Racing Mirrors



Description	Bullet Style
Mounting	Universal
Head Shape	Round
Finish	Chrome
Head Dia.	4" (100mm)
Lens Type	Flat
RH/LH	Universal
Mount Type	Screw/External
Bolt Dia.	N/A
Fixing Centres	2"
Part No	GAM105
Price	£14.95



Description	Bullet Style
Mounting	Universal
Head Shape	Round
Finish	Chrome
Head Dia.	4" (100mm)
Lens Type	Convex
RH/LH	Universal
Mount Type	Screw/External
Bolt Dia.	N/A
Fixing Centres	2"
Part No	GAM105C
Price	£16.96



Description	Bullet Style
Mounting	Universal
Head Shape	Round
Finish	Chrome
Head Dia.	4" (100mm)
Lens Type	Flat
RH/LH	Universal
Mount Type	Screw/External
Bolt Dia.	N/A
Fixing Centres	1" & 3 1/2"
Part No	222-372
Price	£34.96



Description	Bullet Style
Mounting	Universal
Head Shape	Round
Finish	Stainless Steel
Head Dia.	4" (100mm)
Lens Type	Flat
RH/LH	RH
Mount Type	Tex Base
Bolt Dia.	N/A
Fixing Centres	1" 1/2"
Part No	GAM106
Price	£49.96



Description	Bullet Style
Mounting	Universal
Head Shape	Round
Finish	Stainless Steel
Head Dia.	4" (100mm)
Lens Type	Flat
RH/LH	LH
Mount Type	Tex Base
Bolt Dia.	N/A
Fixing Centres	1" 1/2"
Part No	GAM107
Price	£49.96

British Leyland Style



Description	British Leyland Style
Mounting	Door*
Head Shape	Rectangle
Finish	Stainless Steel
Head Size	3 1/2" x 5 3/4" (90mm x 146mm)
Lens Type	Convex
RH/LH	RH
Mount Type	Tex Base
Bolt Dia.	N/A
Fixing Centres	2 1/4"
Part No	GAM215A
Price	£23.95



CONVEX

Description	British Leyland Style
Mounting	Door*
Head Shape	Rectangle
Finish	Stainless Steel
Head Size	3 1/2" x 5 3/4" (90mm x 146mm)
Lens Type	Convex
RH/LH	LH
Mount Type	Tex Base
Bolt Dia.	N/A
Fixing Centres	2 1/4"
Part No	GAM216A
Price	£23.95



FLAT

Description	British Leyland Style
Mounting	Door*
Head Shape	Rectangle
Finish	Stainless Steel
Head Size	3 1/2" x 5 3/4" (90mm x 146mm)
Lens Type	Flat
RH/LH	RH
Mount Type	Tex Base
Bolt Dia.	N/A
Fixing Centres	2 1/4"
Part No	GAM217X
Price	£24.95



FLAT

Description	British Leyland Style
Mounting	Door*
Head Shape	Rectangle
Finish	Stainless Steel
Head Size	3 1/2" x 5 3/4" (90mm x 146mm)
Lens Type	Flat
RH/LH	LH
Mount Type	Tex Base
Bolt Dia.	N/A
Fixing Centres	2 1/4"
Part No	GAM218X
Price	£24.95

*Supplied with an angled plinth for vertical door skin mounting.



CONVEX

Description	British Leyland Style
Mounting	Door**
Head Shape	Rectangle
Finish	Stainless Steel
Head Size	3 1/2" x 5 3/4" (90mm x 146mm)
Lens Type	Convex
RH/LH	RH
Mount Type	Tex Base
Bolt Dia.	N/A
Fixing Centres	2 1/4"
Part No	GAM211X
Price	£18.95



CONVEX

Description	British Leyland Style
Mounting	Door**
Head Shape	Rectangle
Finish	Stainless Steel
Head Size	3 1/2" x 5 3/4" (90mm x 146mm)
Lens Type	Convex
RH/LH	LH
Mount Type	Tex Base
Bolt Dia.	N/A
Fixing Centres	2 1/4"
Part No	GAM212X
Price	£18.95



FLAT

Description	British Leyland Style
Mounting	Door**
Head Shape	Rectangle
Finish	Stainless Steel
Head Size	3 1/2" x 5 3/4" (90mm x 146mm)
Lens Type	Flat
RH/LH	RH
Mount Type	Tex Base
Bolt Dia.	N/A
Fixing Centres	2 1/4"
Part No	GAM258X
Price	£18.95

**Supplied with the standard plinth for horizontal, slightly angled or curved door mounting.



FLAT

Description	British Leyland Style
Mounting	Door**
Head Shape	Rectangle
Finish	Stainless Steel
Head Size	3 1/2" x 5 3/4" (90mm x 146mm)
Lens Type	Flat
RH/LH	LH
Mount Type	Tex Base
Bolt Dia.	N/A
Fixing Centres	2 1/4"
Part No	GAM259X
Price	£18.95



FLAT

Description	British Leyland Style
Mounting	Door**
Head Shape	Rectangle
Finish	Black
Head Size	3 1/2" x 5 3/4" (90mm x 146mm)
Lens Type	Flat
RH/LH	RH
Mount Type	Tex Base
Bolt Dia.	N/A
Fixing Centres	2 1/4"
Part No	GAM261X
Price	£19.96



FLAT

Description	British Leyland Style
Mounting	Door**
Head Shape	Rectangle
Finish	Black
Head Size	3 1/2" x 5 3/4" (90mm x 146mm)
Lens Type	Flat
RH/LH	LH
Mount Type	Tex Base
Bolt Dia.	N/A
Fixing Centres	2 1/4"
Part No	GAM262X
Price	£19.96

Lucas Long Arm, Spring Back



FLAT

Description	Lucas Long Arm, Curved***
Mounting	Wing
Head Shape	Round
Finish	Chrome
Head Size	3 1/2" (90mm)
Lens Type	Flat
RH/LH	Universal
Mount Type	Stud/Internal
Bolt Dia.	5/8"
Fixing Centres	N/A
Part No	GAM1001
Price	£29.95



CONVEX

Description	Lucas Long Arm, Straight***
Mounting	Wing
Head Shape	Rectangle
Finish	Chrome
Head Size	3 1/2" x 5 3/4" (90mm x 146mm)
Lens Type	Convex
RH/LH	Universal
Mount Type	Stud/Internal
Bolt Dia.	3/4"
Fixing Centres	N/A
Part No	GAM117
Price	£29.95



FLAT

Description	Lucas Long Arm, Straight***
Mounting	Wing
Head Shape	Rectangle
Finish	Chrome
Head Size	3 1/2" x 5 3/4" (90mm x 146mm)
Lens Type	Flat
RH/LH	Universal
Mount Type	Stud/Internal
Bolt Dia.	3/4"
Fixing Centres	N/A
Part No	GAM118
Price	£29.95

***Wing mounted mirror with spring back arm.

Lucas Classic Mirrors



CONVEX

Description	Lucas Classic
Mounting	Universal
Head Shape	Round
Finish	Chrome
Head Size	4 1/2" (112mm)
Lens Type	Convex
RH/LH	RH
Mount Type	Stud/Internal
Bolt Dia.	1/2"
Fixing Centres	N/A
Part No	WM1904
Price	£11.95



CONVEX

Description	Lucas Classic
Mounting	Universal
Head Shape	Round
Finish	Chrome
Head Size	4 1/2" (112mm)
Lens Type	Convex
RH/LH	LH
Mount Type	Stud/Internal
Bolt Dia.	1/2"
Fixing Centres	N/A
Part No	WM1905
Price	£11.95



FLAT

Description	Lucas Classic
Mounting	Universal
Head Shape	Round
Finish	Chrome
Head Size	4 1/2" (112mm)
Lens Type	Flat
RH/LH	RH
Mount Type	Stud/Internal
Bolt Dia.	1/2"
Fixing Centres	N/A
Part No	WM1906
Price	£11.95



FLAT

Description	Lucas Classic
Mounting	Universal
Head Shape	Round
Finish	Chrome
Head Size	4 1/2" (112mm)
Lens Type	Flat
RH/LH	LH
Mount Type	Stud/Internal
Bolt Dia.	1/2"
Fixing Centres	N/A
Part No	WM1907
Price	£11.95



FLAT

Description	Lucas Classic
Mounting	Universal
Head Shape	Round
Finish	Chrome
Head Size	4 1/2" (112mm)
Lens Type	Flat
RH/LH	Universal
Mount Type	Screw/External
Bolt Dia.	N/A
Fixing Centres	1 7/8"
Part No	GAM1001X
Price	£29.95



MIRROR PART NO. 222-355
(SEE PAGE 26)

Quarter Light Mirrors



FLAT

Description	Oblong Style
Mounting	Quarter Light
Head Shape	Rectangle
Finish	Chrome
Head Size	3" x 4 1/2" (76mm x 112mm)
Lens Type	Flat
RH/LH	N/A
Mount Type	Clamp-On
Bolt Dia.	N/A
Fixing Centres	N/A
Part No	GAM115
Price	£21.95



FLAT

Description	Round Style
Mounting	Quarter Light
Head Shape	Round
Finish	Stainless Steel
Head Size	3" (76mm)
Lens Type	Flat
RH/LH	N/A
Mount Type	Clamp-On
Bolt Dia.	N/A
Fixing Centres	N/A
Part No	GAM300
Price	£10.55



FLAT

Description	Round Style
Mounting	Quarter Light
Head Shape	Round
Finish	Stainless Steel
Head Size	4" (100mm)
Lens Type	Flat
RH/LH	N/A
Mount Type	Clamp-On
Bolt Dia.	N/A
Fixing Centres	N/A
Part No	GAM301
Price	£10.55

INTERIOR

Accessories - GENERAL



FRONT

BACK

Adjustable Lumbar Support

Our pneumatic lumbar support cushion is designed to give extra support to your lower back. Adjustment is made with a manual pump and release valve. Designed to be fitted inside the seat squab, in between the cover and supporting foam.

Description	Part No	Price
Seat Lumbar Support	MXV1137X	£39.95

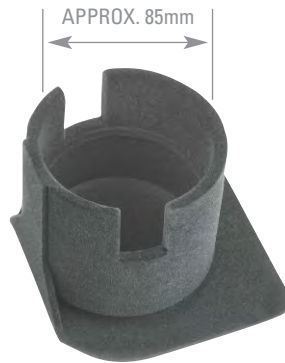

APPROX. 85mm

Cup Holder

Slips neatly over the edge of a footwell mat. 3 1/4" diameter holder with handle cut outs suits most travel cups.

Description	Part No	Price
Cup Holder	100-785	£17.95



Folding Cup Holder

This cup holder features expandable cup grip to suit your cup size and folds away neatly when not required. Requires screw fixing to car's interior.

Description	Part No	Price
Folding Cup Holder (Screw-On)	222-090	£7.96

Fire Extinguishers

In the UK, nearly 300 cars a day catch fire resulting in damage or full loss of the vehicle, whether the car is road legal and insured or being restored, this sort of accident can cost you dearly. A fire extinguisher is essential to any workshop or car tool kit.



Description	Part No	Price
Fire Extinguisher, 600g	GAC99131	£16.94



Description	Part No	Price
Fire Extinguisher, 950g	GAC99141	£19.94

Seat Belts & Harnesses

Fitting and using high quality and well maintained seat belts or harnesses is essential to the safety of yourself and your passengers. In an accident, seat belts are designed to stretch to absorb the energy from your body, once this has happened they will not return to their original length and will need replacing. Any worn, aged or frayed areas of the belt webbing or mechanism could cause the belt to fail.



Seat Belts & Harnesses - SEAT HARNESSSES

Seat Harness - Road Use

This range of Securon harness kits are suitable for road use and off road events, such as track days etc (check event regulations). These harnesses are E marked and legal for road use in the UK.

Type A: This 3 point harness feature 2" webbing with bolt through plate mountings (use with bolts TT7969). Fully adjustable lap and shoulder straps with a buckle catch.

Type B: This 4 point harness feature 2" webbing with bolt through plate mountings (use with bolts TT7969). Fully adjustable lap and shoulder straps with a buckle catch.

Type C: This 3 point harness feature 2" webbing with clip-in snap hook mountings (use with eye bolts TT7967). Fully adjustable lap and shoulder straps with load spreaders on lap belts and a buckle catch.

Type D: This 4 point harness feature 2" webbing with clip-in snap hook mountings (use with eye bolts TT7967). Fully adjustable lap and shoulder straps with load spreaders on lap belts and a buckle catch.

Please Note: Bolts (Part No TT7969) and eye bolts (Part No: TT7967) require the use of special reinforced nuts (Part No: TT7968).



Road Specification

Description	Point	Attachment	Webb	Colour	Part No	Price
Type A	3	Bolt Through	2"	Black	SBH628BLACK	£33.65
Type A	3	Bolt Through	2"	Red	SBH628RED	£33.65

Road Specification

Description	Point	Attachment	Webb	Colour	Part No	Price
Type B	4	Bolt Through	2"	Black	SBH629BLACK	£29.15
Type B	4	Bolt Through	2"	Red	SBH629RED	£29.15



Road Specification

Description	Point	Attachment	Webb	Colour	Part No	Price
Type C	3	Clip-On Snap	2"	Black	SBH605BLACK	£39.80
Type C	3	Clip-On Snap	2"	Blue	SBH605BLUE	£39.80
Type C	3	Clip-On Snap	2"	Red	SBH605RED	£39.80



Road Specification

Description	Point	Attachment	Webb	Colour	Part No	Price
Type D	4	Clip-On Snap	2"	Black	SBH655BLACK	£45.85
Type D	4	Clip-On Snap	2"	Blue	SBH655BLUE	£45.85
Type D	4	Clip-On Snap	2"	Red	SBH655RED	£45.85

Seat Harness - Competition Use

Competition harnesses feature 3" pebble weave webbing with clip-in snap hook mountings (use with eye bolts TT7967). Fully adjustable lap and shoulder straps with a turn lever buckle. Crotch straps can be added to create a 6 point harness if required. Approved for International (RAC/MSA/FIA) and National motor sport use. Not 'E' approved for road use.

Please Note: Bolts (Part No TT7969) and eye bolts (Part No: TT7967) require the use of special reinforced nuts (Part No: TT7968).



Competition FIA Specification

Description	Point	Attachment	Webb	Colour	Part No	Price
FIA Spec	4	Clip-On Snap/ Turn Buckle	3"	Black	SBH693BLACK	£117.95
FIA Spec	4	Clip-On Snap/ Turn Buckle	3"	Red	SBH693RED	£117.95



Seat Belt & Harness Fittings

Description	Eye Bolt
Application	Belt to Car Attachment
Quantity	Pair
Part No	TT7967
Price	£7.15



Description	Nut Plates
Application	Belt to Car Attachment
Quantity	Pair
Part No	TT7968
Price	£6.16



Description	Bolt & Spacer Set
Application	Belt to Car Attachment
Quantity	Pair
Part No	TT7969
Price	£4.50



Crutch Strap - FIA Harness

Description	Crutch Strap
Webb	3"
Colour	Red
Part No	TT7966
Price	£19.96



Shoulder Pads - Securon

Description	Shoulder Pads
Colour	Red
Quantity	Pair
Part No	TT7970
Price	£20.35

Seat Belts & Harnesses - SEAT BELT KITS

Seat Belt Kits

Securon products are manufactured in the UK, and comply with EC and international standards. Securon was founded in 1973 and has grown to be the leading manufacturer of auto safety equipment and is certified to ISO 9001: 2000 quality management systems.

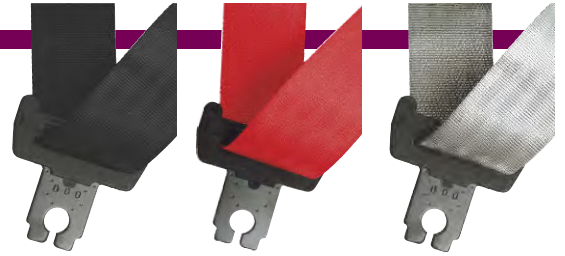

Description	Fitting	Lap	Diag.	Colour	Part No	Price
Automatic, Inertia	Rear	Yes	Yes	Black	SBS254	£47.95
Automatic, Inertia	Rear	Yes	Yes	Grey	SBS254GREY	£63.62



Description	Fitting	Lap	Diag.	Colour	Part No	Price
Static	Rear	Yes	Yes	Black	SBS200	£23.45
Static	Rear	Yes	Yes	Red	SBS200RED	£38.54



Description	Fitting	Lap	Diag.	Colour	Part No	Price
Automatic, Fixed	Front	Yes	Yes	Black	SBS500/30	£40.96
Automatic, Fixed	Front	Yes	Yes	Red	SBS500/30RED	£63.95
Automatic, Fixed	Front	Yes	Yes	Beige	SBS500/30BGE	£55.80



Description	Fitting	Lap	Diag.	Colour	Part No	Price
Auto, Fixed, 15cm Stalk	Front	Yes	Yes	Black	SBS500/15	£47.95
Auto, Fixed, 15cm Stalk	Front	Yes	Yes	Red	SBS500/15RED	£55.10



Description	Fitting	Lap	Diag.	Colour	Part No	Price
Static, 45cm Stalk	Front	Yes	Yes	Black	SBS300/45	£29.56
Static, 45cm Stalk	Front	Yes	Yes	Red	SBS300/45RED	£39.60



Description	Fitting	Lap	Diag.	Colour	Part No	Price
Static	Front	Yes	Yes	Black	SBS300/30	£23.95
Static	Front	Yes	Yes	Red	SBS300/30RED	£35.70



Description	Fitting	Lap	Diag.	Colour	Part No	Price
Auto, Fixed, Web Buckle	Front	Yes	Yes	Black	SBS500/W	£47.95



Description	Fitting	Lap	Diag.	Colour	Part No	Price
Static	Rear	Yes	No	Black	SBS210	£17.95
Static	Rear	Yes	No	Grey	SBS210GREY	£36.70
Static	Rear	Yes	No	Red	SBS210RED	£36.46



Seat Belt & Harness Fittings	
Description	Nut Plates
Application	Belt to Car Attachment
Quantity	Pair
Part No	TT7968
Price	£6.16



Description	Eye Bolt
Application	Belt to Car Attachment
Quantity	Pair
Part No	TT7967
Price	£7.15



Description	Fitting	Lap	Diag.	Colour	Part No	Price
Auto, Adj. Reel 15cm Stalk	Front	Yes	Yes	Black	SBS514/15	£50.00
Auto, Adj. Reel 30cm Stalk	Front	Yes	Yes	Black	SBS514/30	£42.95
Auto, Adj. Reel 30cm Stalk	Front	Yes	Yes	Grey	SBS514/30GREY	£70.96
Auto, Adj. Reel 30cm Stalk	Front	Yes	Yes	Red	SBS514/30RED	£55.96
Auto, Adj. Reel 30cm Stalk	Front	Yes	Yes	Beige	SBS514/30BGE	£55.80
Auto, Adj. Reel 45cm Stalk	Front	Yes	Yes	Black	SBS514/45	£43.85



Belt Extender	
Description	Belt Extender, 40cm
Fitting	N/A
Lap	N/A
Diag.	N/A
Colour	Black
Part No	SBS227
Price	£8.26



Description	Bolt & Spacer Set
Application	Belt to Car Attachment
Quantity	Pair
Part No	TT7969
Price	£4.50

Seat Belts & Harnesses - CLASSIC STYLE SEAT BELTS



Description	Point	Webb	Colour	Part No	Price
Static, Aircraft Style Release	3	2"	Black	AKF1646B	£56.95



Description	Point	Webb	Colour	Part No	Price
Static, Vintage Competition Style	3	2"	Black	MM222-211	£105.95

Dynamat Noise and heat insulation products

Dynamat Xtreme

A highly efficient, composite material designed to reduce noise & vibration through panelwork. It is made from butyl rubber with an aluminium foil layer and a self adhesive backing. The vibration and noise damping qualities make your car feel solid & create a luxury car feel; doors close with a reassuring clunk and no tinny rattles.

Road noise is also reduced so cruising is a more relaxed experience. Recommended usage: Use on interior panelwork. Idea for floor pans, bulkheads, inner wings, inside roof panels & hard tops, doors, bonnet & boot lid. A minimum coverage of 30% panel area, centrally positioned, is recommended to reduce panel vibration and noise.



Description	Xtreme - Speaker Pack	Xtreme - Hex Pack	Xtreme - Door Pack	Xtreme - Bulk Pack	Xtreme - Mega Pack
Quantity	2 Sheets	1 Sheet	4 Sheets	9 Sheets	9 Sheets
Size (mm)	254 x 254mm (0.13sqm)	457 x 812mm (0.37sqm)	305 x 914mm (1.12sqm)	457 x 812mm (3.34sqm)	609 x 1219mm (6.68sqm)
Size (inches)	10 x 10" (1.4sqft)	18 x 32" (4sqft)	12 x 36" (12sqft)	18 x 32" (36sqft)	24 x 48" (72sqft)
Part No	GAC90511	GAC90512	GAC90513	GAC90514	GAC90515
Price	£12.95	£19.96	£69.95	£149.95	£289.96



Dynamat Superlite

A light weight alternative to Xtreme. With excellent noise, vibration & heat reduction characteristics but 30% lighter than Xtreme.

Description	Superlite - Tri-Pack	Superlite - Bulk Pack
Quantity	3 Sheets	12 Sheets
Size (mm)	457 x 812mm (1.11sqm)	457 x 812mm (4.45sqm)
Size (inches)	18 x 32" (12sqft)	18 x 32" (48sqft)
Part No	GAC90521	GAC90522
Price	£50.95	£189.95



Dynaliner

Dynaliner is an ultra-light weight, durable single layer insulation material that can be used as an alternative to traditional underfelt. It provides acoustic isolation and excellent thermal insulation. Dynaliner is also crush & tear resistant, it does not absorb water and is not affected by oil. It is available in a variety of thicknesses to suit the application.

Recommended usage: Use over the top of Dynamat Xtreme or Superlite but under carpets & behind trim. Ideal for floor pans, bulkheads, inner wings, inside roof panels & hard tops, doors, bonnet & boot lid. See website for more information.

Description	Dynaliner	Dynaliner	Dynaliner
Thickness	1/8"	1/4"	1/2"
Quantity	1 Sheet	1 Sheet	1 Sheet
Size (mm)	813 x 1372mm (1.12sqm)	-	-
Size (inches)	32" x 54" (12sqft)	-	-
Part No	GAC90531	GAC90532	GAC90534
Price	£39.95	£59.95	£85.96

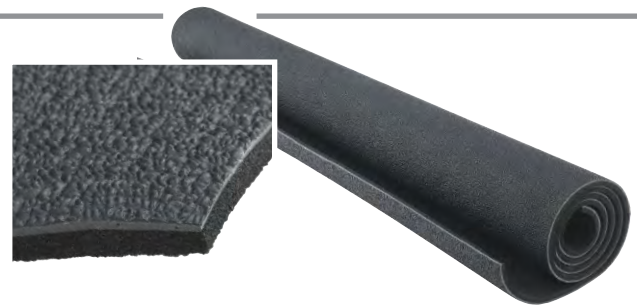

Dynadeck

Dynadeck is a weather proof and wear resistant material ideal for replacing carpet, hardura and rubber type materials in classic cars. Dynadeck combines a 1/8" thick embossed, textured vinyl covering with a 1/4" Dynaliner backing. Non-adhesive so it can be removed for cleaning etc.

Description	Dynadeck	Dynadeck
Thickness	3/8"	3/8"
Quantity	1 Sheet	1 Sheet
Size (mm)	1370 x 1820mm (2.5sqm)	1370 x 3650mm (5sqm)
Size (inches)	32" x 54" (12sqft)	54 x 72" (54sqft)
Part No	GAC90552	GAC90554
Price	£349.96	£629.95



DynaPad

DynaPad is a four layer composite barrier for extra hard to control noise problems. It is a heavy, one pound per square foot mat for use on diesel truck floors and car audio installations. DynaPad has a vinyl barrier between two layers of acoustic foam and a waterproof poly facing. It has no adhesive so it can be reused.

Description	DynaPad
Thickness	3/8"
Quantity	1 Sheet
Size (mm)	813mm x 1372mm (1.12sqm)
Size (inches)	32" x 54" (12sqft)
Part No	GAC90571
Price	£134.95

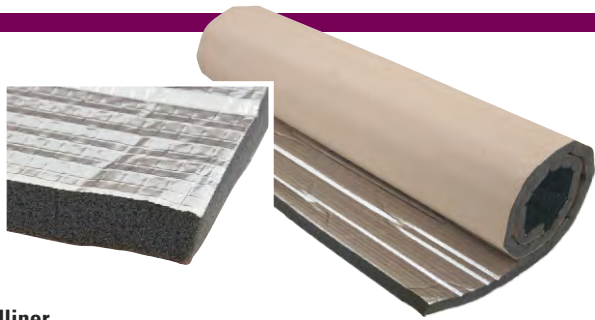

Hoodliner

Designed specifically for under bonnet insulation Hoodliner absorbs engine noise to help keep your car quieter. The aluminized skin creates a water & oil barrier that reflects up to 97% of radiant heat to protect the bonnet's paint.

Description	Hoodliner
Thickness	3/4"
Quantity	1 Sheet
Size (mm)	813mm x 1372mm (1.12sqm)
Size (inches)	32" x 54" (12sqft)
Part No	GAC90541
Price	£69.95



Dynaplate

Dynaplate is a very thin, strong and light weight sound deadener. The solid aluminium sheet is self-adhesive. Use Dynaplate where space is an issue or to bridge openings in body panels. It's a great product to help turn a door into a speaker enclosure.

Description	Dynaplate
Thickness	1/100"
Quantity	1 Sheet
Size (mm)	609 x 762mm (1.39sqm)
Size (inches)	24" x 30" (15sqft)
Part No	GAC90561
Price	£224.95



Dynamat Accessories & Tools

Description	Part No	Price
Switch-a-Blade	GAC90591	£39.95
Economy Wood Roller	GAC90592	£12.95
Professional Rubber Roller 2 inches	GAC90593	£18.95
Dynamat Gloves Small	GAC90594	£39.95
Dynamat Gloves Medium	GAC90595	£39.95
Dynamat Gloves Large	GAC90596	£39.95
Dynamat Gloves X Large	GAC90597	£39.95

What is Dynamat?



Dynamat is the leading range of noise and heat insulation products. If your car is too noisy & hot Dynamat products can give your car the quiet, cool quality feel you deserve.

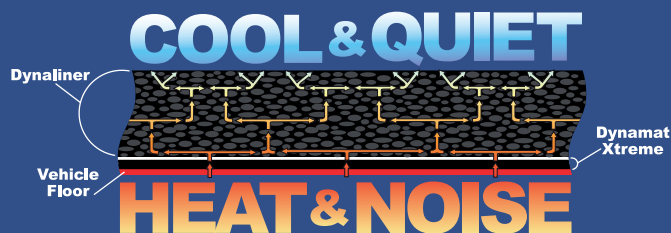

Why Dynamat?

- Deadens panel vibration
- Up to 10 x times more damping than anything else on the market
- Reduces road noise
- Reduces heat soak from engine & exhaust
- Non absorbent materials
- Self adhesive 'peel & stick'
- Easily cut & moulded to fit
- Long lasting & superb adhesion

How Much Dynamat?

Calculate the area of the vehicle you want to cover...

100% COVERAGE - Full coverage for the best results...

If the car is stripped out this is a great time to go for 100% coverage.

50% COVERAGE - Great sound & heat insulation...

Cover 50% of your car's interior panelwork giving you a cooler & quieter car...

30% COVERAGE - Significant reduction in noise...

Cover 30% of the panel's area with a centrally positioned piece of Dynamat to significantly reduce noise...

Where should I use Dynamat?

There are 2 Steps to a quieter, cooler, better feeling great car...

Combine Dynamat with Dynaliner and you get a the benefits of both products.

Step 1

Dynamat - deaden the noise
Apply Dynamat to all the accessible interior panels of your car. Dynamat is best for noise reduction with some heat reduction... Start with firewall/bulkheads, gearbox tunnel, front floors, doors, rear floors, roofs, wheel arches, under bonnet, boot lid.

Step 2

Dynaliner - insulate against heat
Apply Dynaliner over the top of Dynamat to reduce heat soak by up to 70%. Also helps with noise reduction.

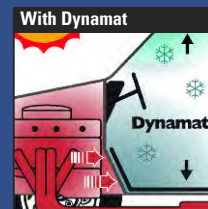



EVANS WATERLESS COOLANT

Protect your investment and provide lifetime cooling!

Evans waterless engine coolant is a unique and revolutionary engine coolant fluid formulated to improve efficiency and reduce corrosion of your car's cooling system, protecting your cherished classic.

It neither contains water nor requires mixing with water, overcoming the limitations associated with using water in engine cooling systems, such as boiling and corrosion. Evans offer a full range of coolant to suit vintage, classic and modern car cooling systems, telephone or visit moss-europe.co.uk

London 020 8867 2020 Bradford 01274 539 999 Bristol 0117 923 2523 Manchester 0161 480 6402 Paris 01 30 80 20 30

NEW
FREE* CATALOGUES



96 PAGES



112 PAGES



216 PAGES



300 PAGES



140 PAGES



208 PAGES



328 PAGES



176 PAGES



152 PAGES



88 PAGES

AVAILABLE SOON...

PARTS & ACCESSORIES CATALOGUES 2014

FIVE EASY WAYS TO ORDER YOUR CATALOGUE



Call: 0800 281 182 freephone

Online: moss-europe.co.uk

Pick up in branch

Email: catalogues@moss-europe.co.uk

Post: complete and send the form to us at...

Customer Services, Moss Europe Ltd, Unit 16, Hampton Business Park, Bolney Way, Feltham TW13 6DB England

*Catalogue P&P per item: Mainland UK Free, EU £5.83 (plus applicable VAT), Non Mainland UK & ROW £7.00

Please for a FREE* catalogue

MG T-Type MGA MGB Sprite&Midget Morris Minor TR2-4A TR5-6 Spitfire Classic Mini Restoration Tools

Name _____ Customer No. _____ Tel no. _____

Email _____ Address _____

Postcode _____

Moss Europe will not share your information with any other party. Moss may use it to send you product and special offer information. If you would prefer not to receive this please tick here

Oil System - OIL COOLERS

Oil Thermostat

The standard oil thermostat has easy push fit connections for original rubber hoses and is supplied with hose clips. Its function is to seal off the radiator completely from oil flow until 74°C is reached. The full flow system allows oil to pressurise the oil radiator at all times, but restricts the oil to by-pass through the thermostat until 74°C is reached.



Oil Thermostat

Description	Connection	Thread	Part No	Price
Thermostat, Standard	Push On	1/2"	TT2960	£43.96
Thermostat, Full Flow	Screw On	1/2"	TT29602	£132.95
Thermostat, Full Flow	Push On	5/8"	TT29604	£123.95



Oil Temperature Sender

Description	Hose Connection	Hose	Boss Thread	Part No	Price
Sender Adaptor	Push On	1/2"	5/8" UNF	TT2969	£44.95
Sender Adaptor	Screw On	1/2"	5/8" UNF	TT29691	£75.95

Oil Catch Tank

An oil catch tank is a must for track or competition use to prevent oil spillage on the track and oil vapour settling around the engine bay. Designed to be connected to the crankcase ventilation system, catching the oil vapour, allowing the air to vent through the special cap.

Manufactured from high grade aluminium and anodised for a smart, durable finish they feature 2 x 1/2" OD connectors for the breather hoses, level indicator, breather cap and drain plug. Note: 2lt tank is minimum size required for FIA approval.



Description	Material	Thread BSP	Part No	Price
Tank, 1 Litre (1000ml)	Aluminium	1/2"	TT2900	£139.96
Tank, 2 Litre (2000ml)	Aluminium	1/2"	TT2901	£155.95



Oil System Union

Description	Thread BSP	Quantity	Part No	Price
Union, 90 Degree	1/2"	2	TT9960	£9.40
Union, Straight	1/2"	2	TT9961	£9.30
Union, 45 Degree	1/2"	2	TT9962	£9.70

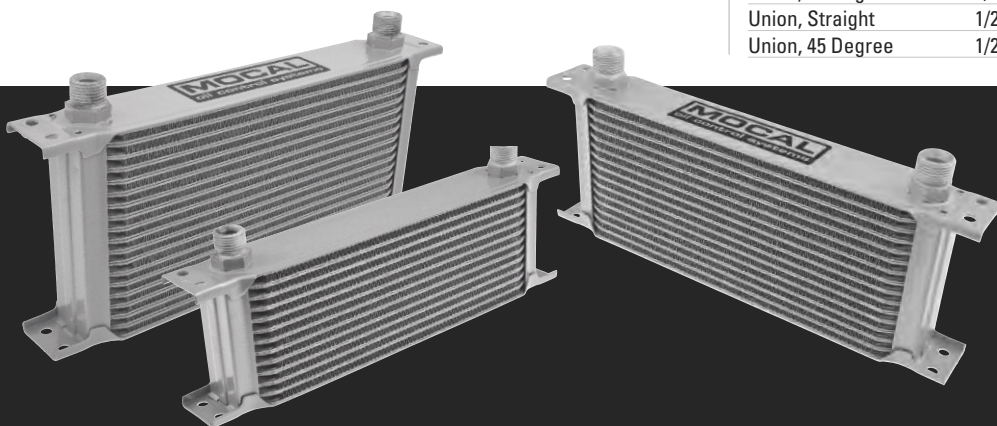

Oil Cooler Radiator

It is wise when modifying engines to allow for extra cooling, the oil should not be allowed to run too cool or too hot as this can lead to rapid engine wear. Installation Kits are available separately and include ready assembled hoses in rubber or braided stainless steel.

Description	Application	Fittings BSP	Brand	Part No	Price (ea)
10 Row Radiator	Road	1/2"	Mocal	AR09807	£65.95
13 Row Radiator	Fast Road	1/2"	Mocal	AR09809	£74.95
13 Row Radiator	Fast Road	1/2"	Moss	ARA221	£34.96
16 Row Radiator	Sprint	1/2"	Mocal	AR09875	£84.95
16 Row Radiator	Sprint	5/8"	Mocal	TT29641	£107.95
19 Row Radiator	Race	1/2"	Mocal	AR09888	£89.95

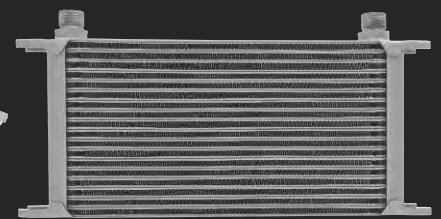

19 ROW RADIATOR

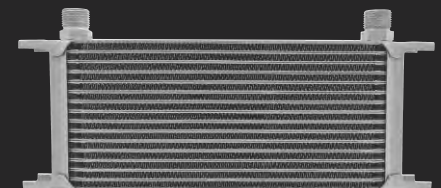

16 ROW RADIATOR



13 ROW RADIATOR

Oil System - BREATHER FILTERS

Engine Breather Filter

A good engine breather system is essential to ensure the smooth running of an engine. These filters can be added into a standard or modified breather system to improve looks and aid the engine breathing. K&N filters include filter oil.

				
Description K&N Filter	Description K&N Filter	Description Breather Filter	Description Breather Filter	Description Breather Filter
Filter Dia. 2"	Filter Dia. 2"	Filter Dia. 2"	Filter Dia. 2"	Filter Dia. 2"
Fitment to Push In Hose	Fitment to Push On Pipe	Fitment to Push On Pipe	Fitment to Push On Pipe	Fitment to Push On Pipe
12mm (1/2")	12mm (1/2")	12mm (1/2")	12mm (1/2")	12mm (1/2")
Colour Chrome	Colour Chrome	Colour Blue	Colour Chrome	Colour Red
Part No KN62-1010	Part No KN62-1330	Part No MT1200	Part No MT1201	Part No MT1202
Price £21.46	Price £19.96	Price £6.76	Price £6.76	Price £6.76

Engine Breather Accessories

				
Description Breather Hose	Description Breather Hose	Description Y Piece	Description Y Piece	Description Connector
Size 1/2" ID	Size 5/16" ID	Size 1/2" x 1/2" OD	Size 1/2" x 5/16" OD	Size 1/2" OD
Length 100cm	Length 100cm	Length N/A	Length N/A	Length N/A
Part No BAU5065M	Part No 149608M	Part No UAM1600	Part No 12G2134	Part No 154934
Price £10.20	Price £8.65	Price £4.50	Price £2.56	Price £1.25

Throttle Linkage - THROTTLE LINKAGE & FITTINGS

Throttle Linkage Kit

Webcon linkages provide OEM quality look with a variety of installation options.

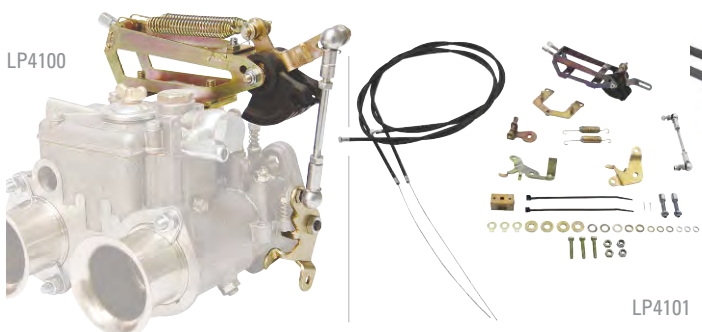

Description	Mounting	Cable	Part No	Price
DCOE Carburettor	Top	Single	LP4100	£96.95
DCOE Carburettor	Top	Twin	LP4101	£102.95

Mangoletsi Linkage Kits

Mangoletsi linkages provide simple set-up and adjustment with a low profile design ideal where under bonnet clearance may be an issue.

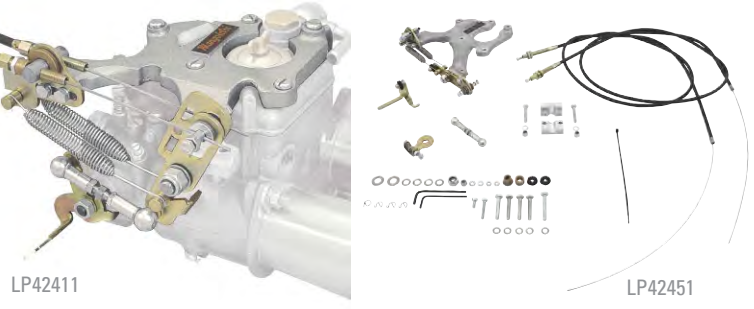

Description	Mounting	Cable	Part No	Price
DCOE Carburettor	Top	Single	LP42411	£81.95
DCOE Carburettor	Top	Twin	LP42451	£93.95



Description	Mounting	Cable	Part No	Price
DCOE Carburettor	Bottom	Single	LP4102	£96.95
DCOE Carburettor	Bottom	Twin	LP4103	£102.95

Fuel System & Induction - INDUCTION



ID No.	Description	Application	Length	Material	Colour	Qty.	Part No	Price
1	Piper Ram Pipe	SU HS2	30mm	Alloy	Silver	1	SFR230	£24.46
2	Piper Ram Pipe	SU HS4	30mm	Alloy	Silver	1	SFR430	£24.46
3	Piper Ram Pipe	SU HIF4	30mm	Alloy	Silver	1	SFR4430	£24.46
4	Piper Ram Pipe	SU HS6	50mm	Alloy	Silver	1	SFR650	£24.46
5	Period Ram Pipe	SU HS2	Short	Alloy	Silver	1	SFR1	£14.20
6	Period Ram Pipe	SU HS4	Short	Alloy	Silver	1	SFR2	£14.20
7	Period Ram Pipe	SU HS6	Short	Alloy	Silver	1	SFR3	£14.20
8	Period Ram Pipe	SU HS2	Long	Alloy	Silver	1	SFR4	£14.20
9	Period Ram Pipe	SU HS4	Long	Alloy	Silver	1	SFR8	£14.20
10	Period Ram Pipe	SU HS6	Long	Alloy	Silver	1	SFR9	£14.20
11	Weber Ram Pipe	40 DCOE	16mm	S/Steel	Silver	1	KNSS1640	£27.95
12	Weber Ram Pipe	40 DCOE	26mm	S/Steel	Silver	1	KNSS2640	£27.95
13	Weber Ram Pipe	40 DCOE	39mm	S/Steel	Silver	1	KNSS3940	£27.95
14	Weber Ram Pipe	45 DCOE	16mm	S/Steel	Silver	1	KNSS1645	£27.95
15	Weber Ram Pipe	45 DCOE	26mm	S/Steel	Silver	1	KNSS2645	£27.95
16	Weber Ram Pipe	45 DCOE	39mm	S/Steel	Silver	1	KNSS3945	£27.95

Ram Pipe

Ram pipes (except period style) are fitted inside the air filter to help smooth the air flow into the carburettor. The shorter the ram pipe, the higher up the rev range power is produced. If using with an air filter, a minimum of 1-1/2" between the ram pipe and the filter case is recommended to ensure maximum air flow.

PIPER STYLE RAM PIPE



PERIOD STYLE RAM PIPE



WEBER STYLE RAM PIPE



See the Moss Restoration
Tools catalogue or visit
moss-europe.co.uk



IF ONLY HE HAD A LEATHERMAN...

Leatherman multi tools are designed for tackling almost any job. Keep one of these with you in your classic 'just in case' of emergencies. Made of the highest quality materials and full of useful tools, these really do it all. The Leatherman Wave®, is their best seller with 17 tools-in-one, whilst the Skeletool® with 7 tools is available in either aluminium or carbon fibre.



moss-europe.co.uk

LEATHERMAN WAVE® SHOWN >



moss-europe.co.uk



For more details see the Moss Restoration
Tools catalogue or visit moss-europe.co.uk



Miller's Oils have designed a range of high performance fuel treatments designed for the classic car enthusiast.

The removal of lead from fuels and addition of ethanol to fuel can cause problems for classic vehicles ranging from valve seat recession to fuel tank/system corrosion. Ethanol also attacks rubber hoses and seals in fuel systems and metallic parts such as brass and zinc. It also attracts water which can cause corrosion and poor starting.

Miller's VSPe Power Plus (Endorsed by FBHVC)



Lead replacement and octane booster with added benefit of ethanol protection. Adds up to 2 octane numbers (20 points) to pump fuel, it prevents valve seat recession and combats the adverse effects of ethanol in fuel. Also contains additives to prevent fuel system corrosion and anti-oxidants to improve fuel life. Recommended for all classic engines previously requiring leaded fuel, now running on unleaded fuel.

VSPe (Endorsed by FBHVC)

Lead replacement with ethanol protection. Prevents valve seat recession and combats the adverse effects of ethanol in fuel. Also contains additives to prevent fuel system corrosion and anti-oxidants to improve fuel life. Recommended for all classic engines previously requiring leaded fuel, now running on unleaded fuel, where an octane improver is not required.

EPS (Endorsed by FBHVC)

Ethanol protection only. Combats the adverse effects of ethanol in fuel, also contains additives to prevent fuel system corrosion. Recommended for classic engines that have been rebuilt (or fitted with a cylinder head that has been rebuilt) using hardened valve seats, previously requiring leaded fuel, now running on unleaded fuel where lead replacement and an octane improver are not required.

CVL - Competition Valve Lubricant

Complies with FIA fuel regulations for historic racing and enables older race engines to run safely on unleaded fuel. Adds 3 octane to base fuel.

CVL Turbo

An out and out octane booster, adding 4 octane to base fuel, ideal for track days and wherever the maximum octane is required. Will give 103 octane when added to Shell V Power.

Fuel System & Induction - INDUCTION

Speedograph Air Filter



Speedograph have been manufacturing high quality performance air filters for many years. All filters feature a chrome plated top and zinc plated base with an outer mesh. The special low restriction filter element is easy to clean with soapy water at normal service intervals.



Application	SU H6/HD6/HS6
Carb. Size	1 3/4"
Filter Depth	1"
Filter Width	5 1/2"
Filter Height	5 1/2"
Filter Hole	Centre
Filter Side	Straight
Part No	SGPF104
Price	£19.50



Application	Weber DCOE
Carb. Size	1 3/4"
Filter Depth	1"
Filter Width	5 1/2"
Filter Height	5 1/2"
Filter Hole	Centre
Filter Side	Straight
Part No	SGPF120
Price	£20.95



Application	SU H8/HD8/HS8
Carb. Size	2"
Filter Depth	1"
Filter Width	5 1/2"
Filter Height	5 1/2"
Filter Hole	Centre
Filter Side	Straight
Part No	SGPF105
Price	£15.95



Application	SU H1
Carb. Size	1 1/8"
Filter Depth	1"
Filter Width	5 1/2"
Filter Height	5 1/2"
Filter Hole	Centre
Filter Side	Straight
Part No	SGPF100
Price	£13.96



Application	Stromberg 150CD/S
Carb. Size	1 1/2"
Filter Depth	1"
Filter Width	5 1/2"
Filter Height	5 1/2"
Filter Hole	Centre
Filter Side	Straight
Part No	SGPF107
Price	£13.96



Application	SU H2/HS2
Carb. Size	1 1/4"
Filter Depth	1"
Filter Width	5 1/2"
Filter Height	5 1/2"
Filter Hole	Centre
Filter Side	Straight
Part No	SGPF101
Price	£13.96



Application	Stromberg 175CD
Carb. Size	1 3/4"
Filter Depth	1"
Filter Width	5 1/2"
Filter Height	5 1/2"
Filter Hole	Centre
Filter Side	Straight
Part No	SGPF108
Price	£13.96



Application	SU H4/HD4/HS4
Carb. Size	1 1/2"
Filter Depth	1"
Filter Width	5 1/2"
Filter Height	5 1/2"
Filter Hole	Centre
Filter Side	Straight
Part No	SGPF102
Price	£13.96

Filter Service Products



Clean air filtration is essential to maintaining a well set up engine and maximising performance. Foam and K&N style filters can be cleaned and reused, unlike the standard disposable paper element filters. See pages 42-43 for K&N filters.



Application	SU H4/HD4/HS4
Carb. Size	1 1/2"
Filter Depth	1"
Filter Width	5 1/2"
Filter Height	5 1/2"
Filter Hole	Offset
Filter Side	Straight
Part No	SGPF102A
Price	£15.50



001-130

901-970

KN99-0621



Application	SU H6/HD6/HS6
Carb. Size	1 3/4"
Filter Depth	1"
Filter Width	5 1/2"
Filter Height	5 1/2"
Filter Hole	Centre
Filter Side	Straight
Part No	SGPF103
Price	£15.95

Description	Size	Part No	Price
K&N Filter Cleaner & Oil Kit	N/A	001-130	£18.95
Foam Filter Cleaner & Oil Kit	N/A	901-970	£9.95
K&N Filter Re-Oil, Aerosol	355ml	KN99-0516	£7.50
K&N Filter Oil, Bottle	250ml	KN99-0533	£4.94
K&N Filter Cleaner, Bottle	1 Litre	KN99-0621	£10.36
K&N Filter Oil, Sachet	14ml	KN99-11312	£5.20

Fuel System & Induction - INDUCTION

K&N Performance Air Filtration



Renowned as being one of the most efficient air filtration systems available. Their reinforced cotton weave is impregnated with a specially formulated oil to retain airborne particles. Offering much improved air-flow over standard paper elements, they are essential for fast road and competition applications. K&N performance filters are designed to be used with stub stacks.



Application	Weber DCOE
Carb. Size	N/A
Filter Depth	1 3/4"
Filter Width	7 1/4"
Filter Height	5"
Filter Hole	Centre
Filter Side	Straight
Part No	KN56-1270
Price	£79.96



Application	SU H2/HS2
Carb. Size	1 1/4"
Filter Depth	1 3/4"
Filter Width	6"
Filter Height	6"
Filter Hole	Centre
Filter Side	Straight
Part No	KN56-9121
Price	£79.96



Application	Weber DCOE
Carb. Size	N/A
Filter Depth	1 3/4"
Filter Width	7 1/4"
Filter Height	5"
Filter Hole	Centre
Filter Side	Straight
Part No	KN56-9106
Price	£84.95



Application	SU H2/HS2
Carb. Size	1 1/4"
Filter Depth	1 3/4"
Filter Width	6"
Filter Height	6"
Filter Hole	Offset
Filter Side	Tapered
Part No	KN56-9335
Price	£79.96



Application	Weber DCOE
Carb. Size	N/A
Filter Depth	2"
Filter Width	7 1/4"
Filter Height	5"
Filter Hole	Centre
Filter Side	Straight
Part No	KN56-9105
Price	£92.95



Application	SU H4/HD4/HS4
Carb. Size	1 1/2"
Filter Depth	1 3/4"
Filter Width	6"
Filter Height	6"
Filter Hole	Offset
Filter Side	Straight
Part No	KN56-9128
Price	£79.96



Application	Weber DCOE
Carb. Size	N/A
Filter Depth	2 1/2"
Filter Width	7 1/4"
Filter Height	5"
Filter Hole	Centre
Filter Side	Straight
Part No	KN56-9104
Price	£87.95



Application	SU H4/HD4/HS4
Carb. Size	1 1/2"
Filter Depth	1 3/4"
Filter Width	6"
Filter Height	6"
Filter Hole	Centre
Filter Side	Straight
Part No	KN56-1390A
Price	£79.96

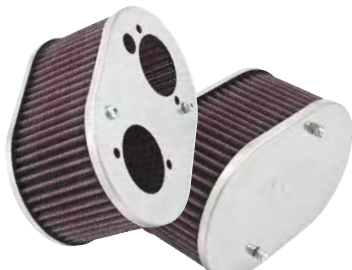

Application	Weber DCOE
Carb. Size	N/A
Filter Depth	3 1/4"
Filter Width	7 1/4"
Filter Height	5"
Filter Hole	Centre
Filter Side	Straight
Part No	KN56-9265
Price	£84.95



Application	SU H4/HD4/HS4
Carb. Size	1 1/2"
Filter Depth	1 3/4"
Filter Width	6"
Filter Height	6"
Filter Hole	Offset
Filter Side	Tapered
Part No	KN56-9320
Price	£79.96



Application	SU H2/HS2
Carb. Size	1 1/4"
Filter Depth	1 3/4"
Filter Width	6"
Filter Height	6"
Filter Hole	Offset
Filter Side	Straight
Part No	KN56-1630A
Price	£87.95



Application	SU H4/HD4/HS4/HIF4/HIF38
Carb. Size	1 1/2"
Filter Depth	1 3/4"
Filter Width	6"
Filter Height	6"
Filter Hole	Centre
Filter Side	Straight
Part No	KN56-9093
Price	£79.96



Application SU H4/HD4/HS4/HIF4/HIF38
Carb. Size 1 1/2"
Filter Depth 3 1/4"
Filter Width 6"
Filter Height 6"
Filter Hole Centre
Filter Side Straight
Part No KN56-9095
Price £74.95



Application SU HIF6/HIF44
Carb. Size 1 3/4"
Filter Depth 1 3/4"
Filter Width 6"
Filter Height 6"
Filter Hole Offset
Filter Side Tapered
Part No KN56-9330
Price £71.95



Application SU H6/HD6/HS6
Carb. Size 1 3/4"
Filter Depth 1 3/4"
Filter Width 6"
Filter Height 6"
Filter Hole Centre
Filter Side Straight
Part No KN56-1400A
Price £89.95



Application SU H8/HD8/HS8
Carb. Size 2"
Filter Depth 2 1/2"
Filter Width 6"
Filter Height 6"
Filter Hole Centre
Filter Side Straight
Part No KN56-9145
Price £92.95



Application SU H6/HD6/HS6
Carb. Size 1 3/4"
Filter Depth 1 3/4"
Filter Width 6"
Filter Height 6"
Filter Hole Centre
Filter Side Straight
Part No KN56-9096
Price £79.96



Application Stromberg 150CD/S
Carb. Size 1 1/2"
Filter Depth 3 1/4"
Filter Width 6"
Filter Height 6"
Filter Hole Centre
Filter Side Straight
Part No KN56-1610A
Price £82.96



Application SU H6/HD6/HS6
Carb. Size 1 3/4"
Filter Depth 3 1/4"
Filter Width 6"
Filter Height 6"
Filter Hole Centre
Filter Side Straight
Part No KN56-9098
Price £79.96



Application Stromberg 175CD
Carb. Size 1 3/4"
Filter Depth 1 3/4"
Filter Width 6"
Filter Height 6"
Filter Hole Centre
Filter Side Straight
Part No KN56-9355
Price £84.95



Application SU H6/HD6/HS6
Carb. Size 1 3/4"
Filter Depth 1 3/4"
Filter Width 6"
Filter Height 6"
Filter Hole Centre
Filter Side Straight
Part No KN56-9132
Price £79.96



Application Holley/Edelbrock
Carb. Size 5.125"
Filter Depth N/A
Filter Width 14"
Filter Height 3"
Filter Hole Centre
Filter Side Straight
Part No KN60-1280
Price £116.95



Application SU H6/HD6/HS6
Carb. Size 1 3/4"
Filter Depth 1 3/4"
Filter Width 6"
Filter Height 6"
Filter Hole Offset
Filter Side Tapered
Part No KN56-9327
Price £84.95



Application SU HIF6/HIF44
Carb. Size 1 3/4"
Filter Depth 1 3/4"
Filter Width 6"
Filter Height 6"
Filter Hole Centre
Filter Side Straight
Part No KN56-9136
Price £83.95

Lighting - HEADLAMPS - 7" BPF & UEC

Headlamp Units - 7" BPF

Replacement headlamp units for existing installations.



GLU501



LU554308

Description	RHD/LHD Dip Side	Lens	Lens Detail	Bulb Type	Sidelight	Part No	Price
Headlamp Unit - BPF Standard	RHD - Dips Left	Glass/Convex	Plain	BPF	No	GLU501	£39.95
Headlamp Unit - BPF Standard	RHD - Dips Left	Glass/Convex	Plain	BPF	Yes*	GLU502	£39.95
Headlamp Unit - BPF Tripod	RHD - Dips Left	Glass/Convex	Tripod	BPF	No	LU554308	£62.95
Headlamp Unit - BPF Tripod	LHD - Dips Right	Glass/Convex	Tripod	BPF	No	LU555296	£60.95



GLB501

*Uses capless bulb GLB501

Headlamp Units - 7" P45 UEC

UEC headlamps were an alternative headlamp type used as the standard throughout continental Europe. They use a shielded bulb with a reflector and lens to focus the light.



27H4146A



163-980

Description	RHD/LHD Dip Side	Lens	Lens Detail	Bulb Type	Sidelight	Part No	Price
Headlamp Unit - UEC P45	LHD - Dips Right	Glass/Convex	Plain	P45	No	27H4146A	£20.80
Headlamp Unit - UEC P45	LHD - Dips Right	Glass/Convex	Plain	UEC	Yes*	27H5981A	£20.80
Headlamp Unit - PL Tripod	LHD - Dips Right	Glass/Convex	Tripod	UEC	No	163-980	£52.96



GLB233

*Uses bayonet bulb GLB233

Headlamp Units - 7" Sealed Beam

Sealed beam units were introduced in the early 1960's and became the standard type of light unit used on many British cars throughout the period and even late into Mini production. The lamp unit is effectively a large bulb comprising of; a pair of filaments, reflector and lens. We are now only able to supply sealed beam units as below.

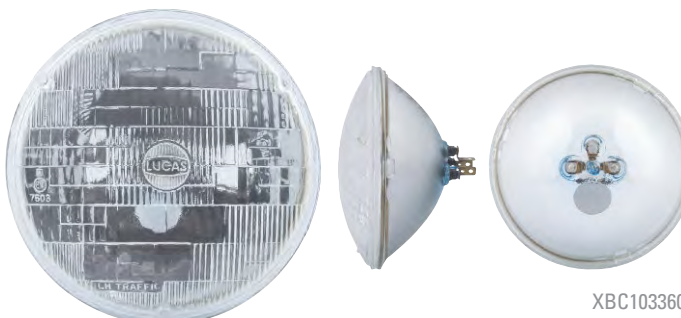

XBC103360



BMK2508

Description	RHD/LHD Dip Side	Lens	Lens Detail	Wattage	Sidelight	Voltage	Part No	Price
Headlamp Unit - Sealed Beam	RHD - Dips Left	Glass/Convex	Lucas	50/75w	Yes*	12V	XBC103360	£19.96
Headlamp Unit - Sealed Beam	LHD - Dips Right	Glass/Convex	GE	50/60w	No	12V	BMK2508	£10.15

*Window type sidelight

Lighting - HEADLAMP ASSEMBLIES - 7" HALOGEN

Headlamp Assemblies - 7" Halogen Panel Mounted

Our range of headlamp assemblies is suitable for most classic British or specialist cars, fitted with 7" type headlamps. They are supplied with the full size bowl for 'in panel' mounting applications. These assemblies include the bucket, mounting rims, lamp unit, H4 bulb (60/55W) & wiring harness.



Description	RHD/LHD Dip Side	Lens	Lens Detail	Bulb Type	Sidelight	Voltage	Rim Fixing	Part No	Price
Headlamp Assembly	RHD - Dips Left	Glass/Convex	Wipac	H4	Yes*	12V	Screw	GAC46311	£54.95
Headlamp Assembly	LHD - Dips Right	Glass/Convex	Wipac	H4	Yes*	12V	Screw	GAC46312	£57.95
Headlamp Assembly	RHD - Dips Left	Glass/Convex	Wipac	H4	Yes*	12V	Clip	GAC46313	£54.95
Headlamp Assembly	LHD - Dips Right	Glass/Convex	Wipac	H4	Yes*	12V	Clip	GAC46314	£57.95
*Uses capless bulb GLB501									
Headlamp Assembly	RHD - Dips Left	Glass/Convex	Wipac	H4	No	12V	Screw	GAC46321	£46.96
Headlamp Assembly	LHD - Dips Right	Glass/Convex	Wipac	H4	No	12V	Screw	GAC46322	£58.96
Headlamp Assembly	RHD - Dips Left	Glass/Convex	Wipac	H4	No	12V	Clip	GAC46323	£44.95
Headlamp Assembly	LHD - Dips Right	Glass/Convex	Wipac	H4	No	12V	Clip	GAC46324	£57.95

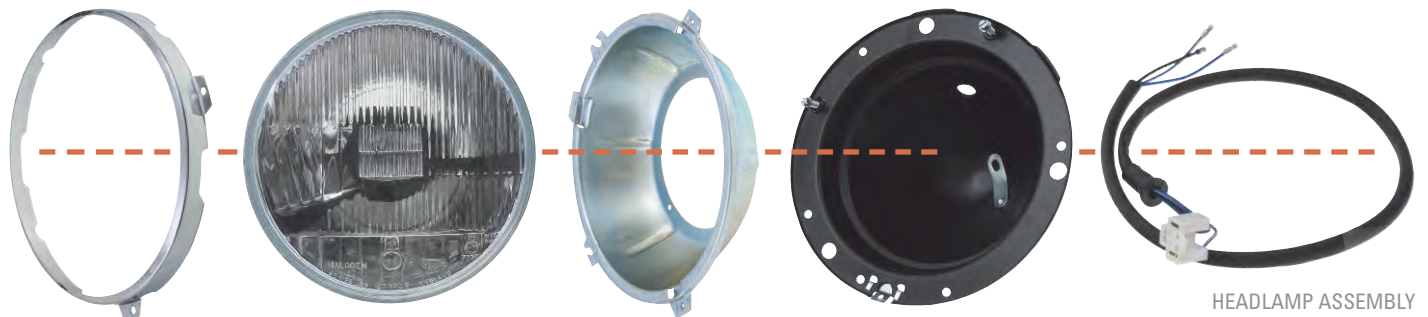

Lighting - HID HEADLAMP CONVERSIONS

PLUG 'N PLAY CONNECTIONS

55w HALOGEN BULBS

CONVERTS STANDARD H4 HALOGEN LAMPS

EMMITS CRISP WHITE LIGHT BEAM

3 TIMES BRIGHTER THAN A 55w HALOGEN BULB

KITS AVAILABLE WITH H4, H1, H7, 9005 & 9006 BULB TYPES

LOW CURRENT DRAW

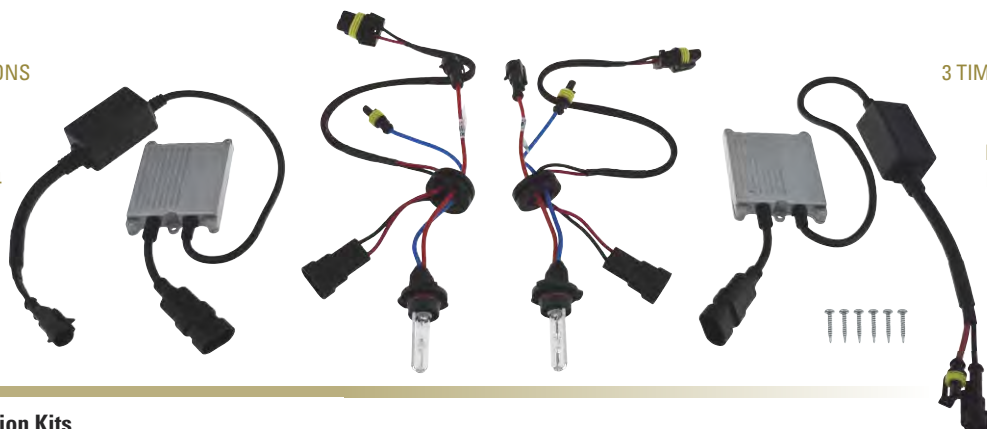

HID Headlamp Conversion Kits

These 5000k HID (High Intensity Discharge) headlamp bulb kits offers a crisp white light that is up to 3 times brighter than a 55w halogen bulb.

The kits use special bulbs that fit the standard 'H' type fittings, and the dip/main function is controlled by a solenoid actuator that accurately positions the beam in the lens.

The kits also benefits by drawing less current than standard bulbs, so loads through original wiring and switches are greatly reduced.



This kit does not include the headlamp units. *If your car is not already fitted with H4 halogen headlamps then you will need to purchase a H4 halogen conversion separately.* Kits are supplied with a pair of bulbs, ballasts, and fittings.

Description	Voltage	Earth	Bulb Type	Part No	Price
HID Kit	12V	Negative	H4	GAC4022H	£147.95
HID Kit	12V	Positive	H4	GAC4022HP	£147.95
HID Kit	12V	Negative	H1	GAC9030	£75.00
HID Kit	12V	Negative	H7	GAC9031	£99.95
HID Kit	12V	Negative	9005	GAC9032	£99.95
HID Kit	12V	Negative	9006	GAC9033	£99.95

Lighting - HEADLAMP CONVERSION KITS & UNITS - 7" HALOGEN

Direct replacement for 7" sealed beam or other type of headlamps these halogen H4 type bulb conversion kits include lamp units, bulbs, dust shields and sidelight fittings, where required.

Headlamp Conversion Kits - 7" Halogen H4 'Wipac' Quadoptic



Description	RHD/LHD Dip Side	Lens	Lens Detail	Bulb Type	Sidelight	Voltage	Part No	Price
Headlamp Conversion Kit	RHD - Dips Left	Glass/Convex	Wipac	H4	No	12V	GAC4022	£39.95
Headlamp Conversion Kit	RHD - Dips Left	Glass/Convex	Wipac	H4	Yes*	12V	GAC4023Z	£39.95
Headlamp Conversion Kit	LHD - Dips Right	Glass/Convex	Wipac	H4	No	12V	MGE203	£49.96
Headlamp Conversion Kit	LHD - Dips Right	Glass/Convex	Wipac	H4	Yes*	12V	WPS4699	£52.96



GLB501

*Uses capless bulb GLB501

Headlamp Conversion Kits - 7" Halogen H4 Lucas



Description	RHD/LHD Dip Side	Lens	Lens Detail	Bulb Type	Sidelight	Voltage	Part No	Price
Headlamp Conversion Kit	RHD - Dips Left	Glass/Convex	Lucas	H4	Yes*	12V	GAC4023	£85.94
Headlamp Conversion Kit	LHD - Dips Right	Glass/Convex	Lucas	H4	Yes*	12V	LULUB802	£90.95
Headlamp Conversion Kit	LHD - Dips Right	Glass/Convex	Lucas	H4	No	12V	LULUB803	£74.95



GLB501

*Uses capless bulb GLB501

Headlamp Conversion Kits - 7" Halogen H4 'Wipac' Freeform

Modern looking lamp units with the beam pattern incorporated into the reflector, rather than the lens, and a plain polycarbonate cover to give a contemporary look to your car. Uses standard H4 bulbs, sold separately.



Description	RHD/LHD Dip Side	Lens	Lens Detail	Bulb Type	Sidelight	Voltage	Part No	Price
Headlamp Conversion Kit	RHD - Dips Left	Plastic/Convex	n/a	H4	No	12V	GAC4022X	£41.95
Headlamp Conversion Kit	RHD - Dips Left	Plastic/Convex	n/a	H4	Yes*	12V	GAC4023X	£44.95



GLB501

*Uses capless bulb GLB501

Headlamp Conversion Kit - 7" Halogen H4 Crystal

Clear glass headlamps available with or without an angel eye ring side light pattern. They include a selection of coloured filters to tint the angel eyes to compliment your car. These are not 'E' marked for road use as they have a vertical, not directional, dip pattern.



GAC4600



GAC4615

Description	RHD/LHD Dip Side	Lens	Lens Detail	Bulb Type	Sidelight	Voltage	Part No	Price
Headlamp Conversion Kit	RHD - Dips Left	Plastic/Convex	n/a	H4	Angle Eye	12V	GAC4600	£51.95
Headlamp Conversion Kit	RHD - Dips Left	Plastic/Convex	n/a	H4	Yes*	12V	GAC4615	£35.70



GLB501

*Uses capless bulb GLB501

Headlamp Units - 7" Halogen H4 'Wipac' Quadoptic

Replacement headlamp units.



WPS4700



WPS4696

Description	RHD/LHD Dip Side	Lens	Lens Detail	Bulb Type	Sidelight	Voltage	Part No	Price
Lamp Unit	RHD - Dips Left	Glass/Convex	Wipac	H4	Yes*	12V	WPS4700	£21.95
Lamp Unit	LHD - Dips Right	Glass/Convex	Wipac	H4	Yes*	12V	WPS4701	£28.94
Lamp Unit	RHD - Dips Left	Glass/Convex	Wipac	H4	No	12V	WPS4696	£18.95
Lamp Unit	LHD - Dips Right	Glass/Convex	Wipac	H4	No	12V	WPS4697	£33.95
Lamp Unit	LHD - Dips Right	Glass/Convex	Wipac	H4	Yes*	12V	WPS4699	£52.96



GLB501

*Uses capless bulb GLB501

H4 Halogen HEADLAMPS

Fitting a Wipac halogen headlamp conversion is one of the most worthwhile improvements you can make to your Classic. Wipac design and manufacture exterior lighting products for the world's premium car makers. These classic style lamps use powerful halogen bulbs combined with an improved convex lens design. Resulting in a superior light beam and pattern to that of the original lamp units. These lamps are available with or without a pilot (side light) and for left or right hand drive vehicles.

The Wipac kits include two lamp units and two 60/55w halogen bulbs. The units can be used with either standard H4 bulbs or replace them with blue tinted, or super white xenon. Super white xenon are approximately 30% brighter than the standard bulb.

Ultimate Night Time Vision



WIPAC

Lighting - HEADLAMP BOWLS, HARNESSSES & FITTINGS

Headlamp Bowls & Fittings - 7" 3 Screw Type



Description	Bucket
Qty. Required	1 (per headlamp)
Lamp Dia	7"
Material	Steel
Outer Rim Type	All
Part No	7H6838
Price (ea)	£19.66



Description	Mounting Rim
Qty. Required	1 (per headlamp)
Lamp Dia	7"
Material	Steel
Outer Rim Type	All
Part No	17H5205
Price (ea)	£14.70



Description	Screw, Mounting Rim
Qty. Required	3 (per headlamp)
Lamp Dia	7"
Material	Plated
Outer Rim Type	All
Part No	AB606021
Price (ea)	£0.17



Description	Adjuster Kit
Qty. Required	1 (per headlamp)
Lamp Dia	7"
Material	Assorted
Outer Rim Type	All
Part No	17H5394K
Price (ea)	£3.65

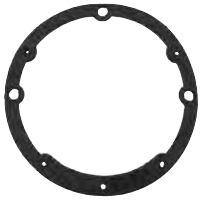

Description	Gasket, Bucket to Body
Qty. Required	1 (per headlamp)
Lamp Dia	7"
Material	Rubber
Outer Rim Type	All
Part No	3H1031
Price (ea)	£3.46

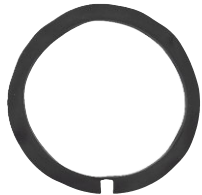

Description	Dust Excluder
Qty. Required	1 (per headlamp)
Lamp Dia	7"
Material	Rubber
Outer Rim Type	All
Part No	3H2962
Price (ea)	£2.65



Description	Rim Clip
Qty. Required	1 (per headlamp)
Lamp Dia	7"
Material	Metal
Outer Rim Type	Screw-on
Part No	37H7421A
Price (ea)	£2.86



Description	Rim Screw
Qty. Required	1 (per headlamp)
Lamp Dia	7"
Material	Chromed
Outer Rim Type	Screw-on
Part No	RTC465
Price (ea)	£0.50



Description	Rim Clip
Qty. Required	1 (per headlamp)
Lamp Dia	7"
Material	Metal
Outer Rim Type	Clip-on
Part No	BAU1460
Price (ea)	£1.66

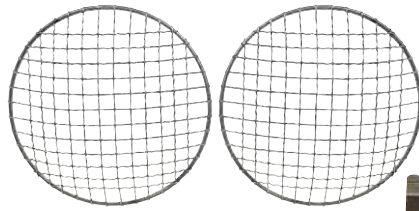

Headlamp Stoneguards
Protect the headlamps with these chrome headlamp guards.

Description	Stoneguards, Mesh
Lamp Diameter	7"
Fitting Type	Clip
Finish	Chrome
Quantity	Pair
Part No	GAC8000X
Price (pair)	£9.95



Headlamp Eyebrows
As fitted to the original Radford de Ville Minis of the 1960s, but also suitable for most 7" round headlamp applications.

Description	Eyebrows, pair
Headlamp Size	7"
Material	Metal
Finish	Chrome
Part No	GAC7999X
Price (pair)	£10.75

Headlamp Bowls & Fittings - 7" 2 Screw & Spring Type



Description	Mounting Rim
Qty. Required	1 (per headlamp)
Lamp Dia	7"
Material	Steel
Outer Rim Type	All
Part No	SML4
Price (ea)	£6.95



Description	Bucket, Plastic
Qty. Required	1 (per headlamp)
Lamp Dia	7"
Material	Plastic
Outer Rim Type	Screw-on
Part No	SML3P
Price (ea)	£13.36



Description	Bucket
Qty. Required	1 (per headlamp)
Lamp Dia	7"
Material	Steel
Outer Rim Type	All
Part No	SML3
Price (ea)	£12.95



Description	Bucket, Repro
Qty. Required	1 (per headlamp)
Lamp Dia	7"
Material	Steel
Outer Rim Type	All
Part No	SML3Z
Price (ea)	£8.26

Headlamp Bowls & Fittings - 7" 3 Screw & Spring Type



Description	Mounting Rim
Qty. Required	1 (per headlamp)
Lamp Dia	7"
Material	Plastic
Outer Rim Type	All
Part No	27H6481
Price (ea)	£23.45

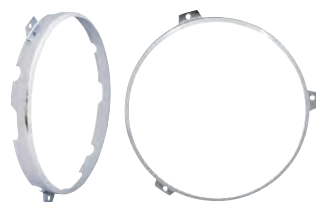

Description	Retaining Rim
Qty. Required	1 (per headlamp)
Lamp Dia	7"
Material	Chrome
Outer Rim Type	All
Part No	515218A
Price (ea)	£6.74



Description	Screw, Retaining Rim
Qty. Required	3 (per headlamp)
Lamp Dia	7"
Material	Plated
Outer Rim Type	All
Part No	AB606021
Price (ea)	£0.17



Description	Adjuster Kit
Qty. Required	1 (per headlamp)
Lamp Dia	7"
Material	Assorted
Outer Rim Type	All
Part No	BHM7058
Price (ea)	£3.95



Description	Gasket, Bucket to Body
Qty. Required	1 (per headlamp)
Lamp Dia	7"
Material	Rubber
Outer Rim Type	All
Part No	13H565
Price (ea)	£2.50

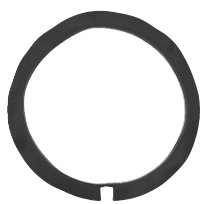

Description	Dust Excluder
Qty. Required	1 (per headlamp)
Lamp Dia	7"
Material	Rubber
Outer Rim Type	All
Part No	3H2962
Price (ea)	£2.65



Description	Rim Clip, Metal Bucket
Qty. Required	1 (per headlamp)
Lamp Dia	7"
Material	Metal
Outer Rim Type	Screw-on
Part No	37H7421A
Price (ea)	£2.86



Description	Rim Clip, Metal Bucket
Qty. Required	1 (per headlamp)
Lamp Dia	7"
Material	Metal
Outer Rim Type	Clip-on
Part No	BAU1460
Price (ea)	£1.66

Headlamp Wiring Harnesses & Fittings



Description	Wiring Harness
Bulb Fitting	BPF
Side Lamp	No
Sleeved	Yes
Part No	27H2333
Price (ea)	£11.95

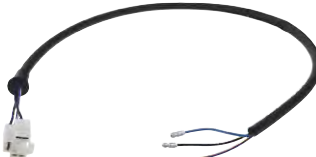

Description	Wiring Harness
Bulb Fitting	H4 3 pin
Side Lamp	No
Sleeved	Yes
Part No	BAU2110
Price (ea)	£6.16



Description	Wiring Harness
Bulb Fitting	H4 3 pin
Side Lamp	Yes, push in
Sleeved	Yes
Part No	BAU2111
Price (ea)	£10.96



Description	Wiring Harness
Bulb Fitting	H4 3 pin
Side Lamp	Yes, window
Sleeved	Yes
Part No	BAU2111X
Price (ea)	£10.96



Description	Wiring Harness
Bulb Fitting	H4 3 pin
Side Lamp	Yes, push in
Sleeved	Yes
Part No	BAU2111W
Price (ea)	£13.20



Description	Dust Cover - Lucas
Bulb Fitting	H4 3 pin
Part No	BAU1770A
Price (ea)	£1.50



Description	Dust Cover - Wipac
Bulb Fitting	H4 3 pin
Part No	WPS5408
Price (ea)	£5.30

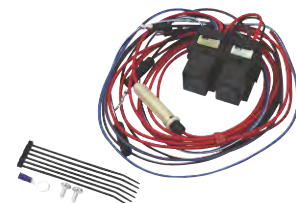

Description	Headlamp Relay Kit
No. of Relays	2
Part No	117-515
Price (ea)	£29.95

Lighting - SPOT & FOG LAMPS



Description	Spot Lamp
Size	5"
Style	Lucas 576
Mounting	Base
Finish	Chrome
H x W x D	145 x 145 x 105mm
Voltage	12V
Qty.	Each
Part No	MM162-700
Price (ea)	£72.95



Description	Spot Lamp
Size	5"
Style	Lucas 576
Mounting	Back
Finish	Chrome
H x W x D	145 x 145 x 105mm
Voltage	12V
Qty.	Each
Part No	57H5322
Price (ea)	£72.95



Description	Spot Lamp
Size	5.5"
Style	Wipac
Mounting	Base
Finish	Chrome
H x W x D	140 x 140 x 50mm
Voltage	12V
Qty.	Pair
Part No	WPS6007
Price (pair)	£29.95



Description	Spot Lamp
Size	5.5"
Style	Universal
Mounting	Base
Finish	Stainless Steel
H x W x D	160 x 160 x 65mm
Voltage	12V
Qty.	Pair
Part No	GAC4610
Price (pair)	£42.47



Description	Spot Lamp
Size	5"
Style	Universal
Mounting	Base
Finish	Stainless Steel
H x W x D	135 x 135 x 70mm
Voltage	12V
Qty.	Pair
Part No	GAC4619
Price (pair)	£37.96



Description	Spot Lamp
Size	7"
Style	SLR700
Mounting	Base
Finish	Chrome
H x W x D	180 x 180 x 115mm
Voltage	12V
Qty.	Each
Part No	LU55081
Price (ea)	£114.95



Description	Spot Lamp
Size	6"
Style	Universal
Mounting	Base
Finish	Black
H x W x D	155 x 155 x 65mm
Voltage	12V
Qty.	Pair
Part No	RL020
Price (pair)	£25.96



Description	Spot Lamp
Size	5"
Style	Angel Eye
Mounting	Base
Finish	Stainless Steel
H x W x D	148 x 148 x 65mm
Voltage	12V
Qty.	Pair
Part No	GAC4601
Price (pair)	£51.00



Lucas 576 Spare Lens Assembly - Spot Lamp	
Description	Lens Assembly, Spot Lamp
Diameter	5"
Style	Lucas 576
Qty.	Each
Part No	57H5015
Price (ea)	£29.95



Description	Fog Lamp
Size	5"
Style	Lucas 576
Mounting	Base
Finish	Chrome
H x W x D	145 x 145 x 105mm
Voltage	12V
Qty.	Each
Part No	MM162-800
Price (ea)	£72.95



Description	Fog Lamp
Size	5"
Style	Lucas 576
Mounting	Back
Finish	Chrome
H x W x D	145 x 145 x 105mm
Voltage	12V
Qty.	Each
Part No	BHA4399
Price (ea)	£72.95



Description	Fog Lamp
Size	5.5"
Style	Wipac
Mounting	Base
Finish	Chrome
H x W x D	140 x 140 x 50mm
Voltage	12V
Qty.	Pair
Part No	WPS6078
Price (pair)	£24.95



Description	Fog Lamp
Size	5"
Style	Angel Eye
Mounting	Base
Finish	Chrome
H x W x D	148 x 148 x 65mm
Voltage	12V
Qty.	Pair
Part No	GAC4602
Price (pair)	£49.96



Description	Fog Lamp
Size	5.5"
Style	Universal
Mounting	Base
Finish	Stainless Steel
H x W x D	160 x 160 x 65mm
Voltage	12V
Qty.	Pair
Part No	GAC4611
Price (pair)	£48.95



Lucas 576 Spare Lens Assembly - Fog Lamp

Description	Lens Assembly, Fog Lamp
Diameter	5"
Style	Lucas 576
Qty.	Each
Part No	ACG5179
Price (ea)	£29.95

Spot & Fog Lamp Accessories



Lamp Wiring Kit

Universal lamp wiring kit includes relay, switch, cable & terminals.

Description	Wiring Fitting Kit, Universal
Part No.	GAC4027
Price (ea)	£11.50



Description	Lucas Lion Logo Lamp Cover
Diameter	6"
Colour	Black With Clear Window
Qty.	Each
Part No	162-705
Price (ea)	£44.95

Lighting - CLASSIC GENERAL LAMPS

Our range of general classic car lamps are from a wide variety of British classics.

Lucas 594 Type - Beehive Lens

These lamps were used on numerous British classics including Land Rovers and Minis. A wide range of lamps are available for use as indicators, side lamps, stop & tail lamps etc.



Description	Lamp Assembly
Contacts	Single Contact
Colour	Amber
Lens Material	Glass
H x W x D	68 x 68 x 50mm
Bulb Type	382
Voltage	12V
Wattage	21W
Part No.	2A9013
Price (ea)	£13.96



Description	Lamp Assembly
Contacts	Single Contact
Colour	Clear
Lens Material	Glass
H x W x D	68 x 68 x 50mm
Bulb Type	207
Voltage	12V
Wattage	5W
Part No.	532806
Price (ea)	£13.96



Description	Lamp Assembly
Contacts	Single Contact
Colour	Red
Lens Material	Glass
H x W x D	68 x 68 x 50mm
Bulb Type	382
Voltage	12V
Wattage	21W
Part No.	2A9040
Price (ea)	£13.96



Description	Lamp Assembly
Contacts	Single Contact
Colour	Amber
Lens Material	Plastic
H x W x D	68 x 68 x 50mm
Bulb Type	382
Voltage	12V
Wattage	21W
Part No.	CHM13
Price (ea)	£7.15



Description	Lamp Assembly
Contacts	Twin Contact
Colour	Clear
Lens Material	Glass
H x W x D	68 x 68 x 50mm
Bulb Type	380
Voltage	12V
Wattage	21/5W
Part No.	1B9100
Price (ea)	£14.10



Description	Lamp Assembly
Contacts	Twin Contact
Colour	Red
Lens Material	Glass
H x W x D	68 x 68 x 50mm
Bulb Type	380
Voltage	12V
Wattage	21/5W
Part No.	1B9101
Price (ea)	£14.10

Replacement Parts: Lucas 594 type



Description	Lens
Colour	Amber
Material	Glass
Part No.	37H5520
Price (ea)	£6.95
Part No.	37H5520Z
Price (ea)	£5.95



Description	Lens
Colour	Red
Material	Glass
Part No.	37H5531
Price (ea)	£6.95
Part No.	37H5531Z
Price (ea)	£5.95



Description	Lens
Colour	Clear
Material	Glass
Part No.	37H6928
Price (ea)	£6.95
Part No.	37H6928Z
Price (ea)	£5.95



Description	Rim
Material	Chrome
Part No.	7H5182
Price (ea)	£1.96



Description	Bulb Holder
Contact	Twin Contact
Part No.	27H5545
Price (ea)	£5.95



Description	Bulb Holder
Contact	Single Contact
Part No.	37H5528
Price (ea)	£7.75



Description	Gaiter
Material	Rubber
Part No.	508162
Price (ea)	£2.35



Description	Bullet Connector
Part No.	27H6713
Price (ea)	£0.65

Lucas 488 Type - Flat Lens

Used on many classics including Austin Healeys and can be used to replace the Beehive lamp to give a flat look.



Description	Lamp Assembly
Contacts	Twin Contact
Colour	Clear
Lens Material	Glass
H x W x D	68 x 68 x 50mm
Bulb Type	380
Voltage	12V
Wattage	21/5W
Part No.	3H3055
Price (ea)	£14.10

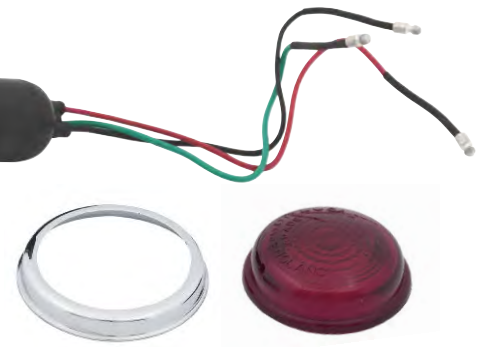

Description	Lamp Assembly
Contacts	Twin Contact
Colour	Red
Lens Material	Glass
H x W x D	68 x 68 x 50mm
Bulb Type	380
Voltage	12V
Wattage	21/5W
Part No.	3H1814
Price (ea)	£14.10

**Replacement Parts: Lucas 488 type**

Description	Lens
Colour	Amber
Material	Glass
Part No.	AJC5114
Price (ea)	£7.95



Description	Lens
Colour	Clear
Material	Glass
Part No.	AJA5076
Price (ea)	£5.95



Description	Lens
Colour	Red
Material	Glass
Part No.	7H5183
Price (ea)	£5.95



Description	Rim
Material	Chrome
Part No.	7H5182
Price (ea)	£1.96



Description	Bulb Holder
Contact	Twin Contact
Bulb Type	380
Part No.	17H5426
Price (ea)	£12.95



Description	Bulb Holder
Contact	Single Contact
Bulb Type	382/207
Part No.	LU573285
Price (ea)	£5.15



Description	Gaiter
Material	Rubber
Part No.	37H5481
Price (ea)	£3.25



Description	Bullet Connector
Part No.	27H6713
Price (ea)	£0.65



Lighting - CLASSIC GENERAL LAMPS

Lucas L539 Type

This lamp is a twin contact type. It can be used as a dual lamp or for single circuits by wiring up the appropriate contact.

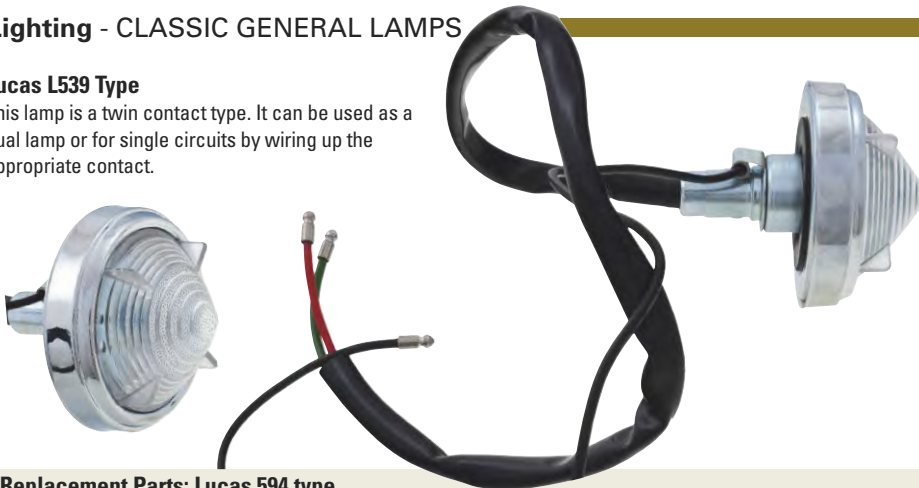

Description	Lamp Assembly
Contacts	Twin Contact
Colour	Clear
Lens Material	Plastic
H x W x D	82 x 82 x 43mm
Bulb Type	380
Voltage	12V
Wattage	21/5W
Part No.	ACC5292
Price (ea)	£26.95

Replacement Parts: Lucas 594 type

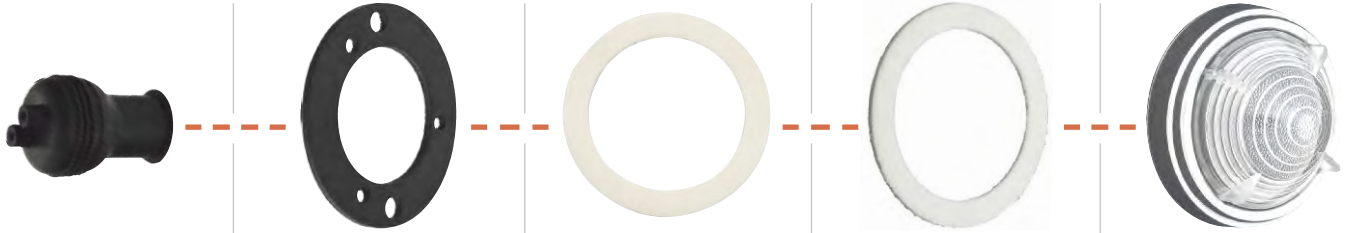

Description	Gaiter
Material	Rubber
Part No.	37H5525
Price (ea)	£1.30

Description	Gasket, Lamp to body
Material	Rubber
Part No.	17H5309
Price (ea)	£0.95

Description	Washer, Lens
Material	Nylon
Part No.	17H5305
Price (ea)	£2.30

Description	Gasket, Lens
Material	Rubber
Part No.	17H5308
Price (ea)	£1.85

Description	Lens & Rim
Material	Plastic
Part No.	17H5428
Price (ea)	£12.20

Lucas 691 Type

Classic looking lamp assembly with wide chrome bezel as used on Austin Healeys, Triumph TR250, Morgans.



Description	Lamp Assembly
Contacts	Single Contact
Colour	Amber
Lens Material	Plastic
H x W x D	80 x 80 x 50mm
Bulb Type	382
Voltage	12V
Wattage	21W
Part No.	BHA4477
Price (ea)	£19.95



Description	Lamp Assembly
Contacts	Single Contact
Colour	Clear
Lens Material	Plastic
H x W x D	80 x 80 x 50mm
Bulb Type	382
Voltage	12V
Wattage	21W
Part No.	BHA4476
Price (ea)	£19.95



Description	Lamp Assembly
Contacts	Twin Contact
Colour	Clear
Lens Material	Plastic
H x W x D	80 x 80 x 50mm
Bulb Type	380
Voltage	12V
Wattage	21/5W
Part No.	BHA4465
Price (ea)	£21.95

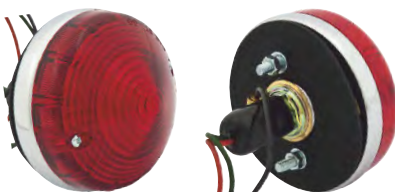

Description	Lamp Assembly
Contacts	Twin Contact
Colour	Red
Lens Material	Plastic
H x W x D	80 x 80 x 50mm
Bulb Type	380
Voltage	12V
Wattage	21/5W
Part No.	BHA4462
Price (ea)	£21.95

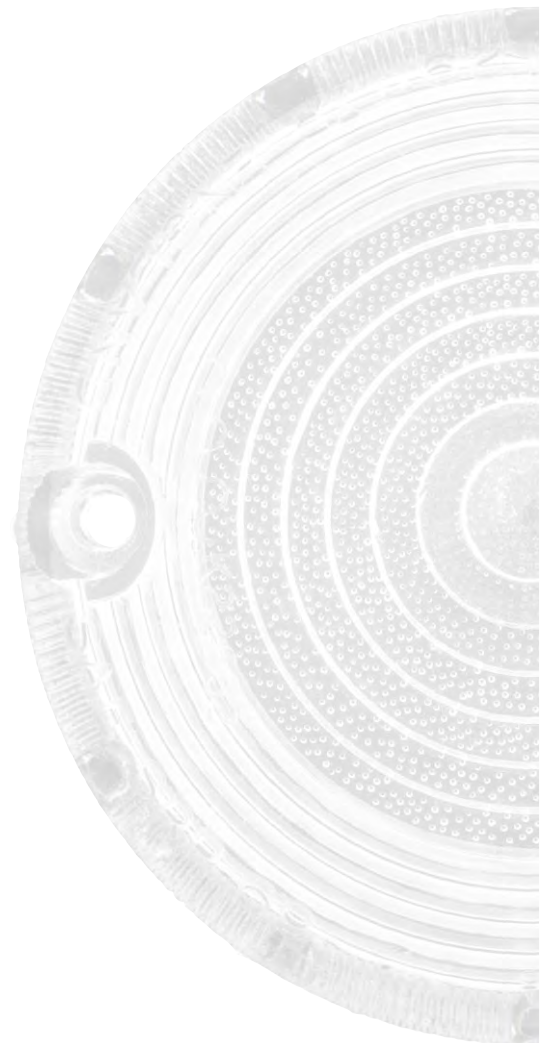

Replacement Parts: Lucas 691 type



Description	Contacts	Colour	Material	Part No	Price (ea)
1 Lens		Amber	Plastic	517266	£11.95
2 Lens		Clear	Plastic	17H6763	£9.55
3 Lens		Red	Plastic	37H6109	£6.20
4 Gasket, Lens				17H6765	£2.65
5 Gasket, Lamp to Body				27H2724	£2.26
6 Gaiter				17H5216	£0.76
7 Contact Repair Kit	Single Contact			37H5452	£2.35
8 Contact Repair Kit	Twin Contact			37H5459	£4.75
9 Screw, Lens to Body				518868	£0.35
10 Washer, Screw			Rubber	21G9057	£0.30

Lucas Dome Type

Used in a variety of applications from late classic Minis to Land Rovers.



Description	Lamp Assembly
Contacts	Single Contact
Colour	Amber
Lens Material	Plastic
H x W x D	75 x 75 x 45mm
Bulb Type	382
Voltage	12V
Wattage	21W
Part No.	AFU3389
Price (ea)	£5.35



Description	Lamp Assembly
Contacts	Single Contact
Colour	Clear
Lens Material	Plastic
H x W x D	75 x 75 x 45mm
Bulb Type	382
Voltage	12V
Wattage	21W
Part No.	AFU3389W
Price (ea)	£5.35



Description	Lamp Assembly
Contacts	Single Contact
Colour	Red
Lens Material	Plastic
H x W x D	75 x 75 x 45mm
Bulb Type	380
Voltage	12V
Wattage	21/5W
Part No.	AFU3389R
Price (ea)	£5.35

Replacement Parts: Lucas dome type



Description	Contacts	Colour	Material	Part No	Price (ea)
1 Lens		Amber	Plastic	CDU3374	£2.15
2 Lens		Clear	Plastic	CDU3374W	£2.15
3 Lens		Red	Plastic	CDU3374R	£2.15
4 Screw, lens to body	Single Contact		S/Steel	518868	£0.35
5 Washer, screw	Twin Contact		Rubber	21G9057	£0.30

Lighting - CLASSIC GENERAL LAMPS

Lucas Dome LED Type

Universal LED lamps, supplied with a connector to fit to Land Rover Defenders which can be removed to allow fitting to other models.



Description	Lamp Assembly
Typical Application	Indicator
Colour	Amber
Lens Material	Plastic
H x W x D	73 x 73 x 40mm
Voltage	12V
Wattage	21W
Part No.	WPS6061LED
Price (ea)	£17.95



Description	Lamp Assembly
Typical Application	Side Light
Colour	Clear
Lens Material	Plastic
H x W x D	74 x 73 x 40mm
Voltage	12V
Wattage	5W
Part No.	WPS6060LED
Price (ea)	£17.95



Description	Lamp Assembly
Typical Application	Stop & Tail
Colour	Red
Lens Material	Plastic
H x W x D	75 x 73 x 40mm
Voltage	12V
Wattage	21/5W
Part No.	WPS6062LED
Price (ea)	£17.95



Description	Lamp Assembly
Typical Application	Indicator, Front
Colour	Clear
Lens Material	Plastic
H x W x D	76 x 73 x 40mm
Voltage	12V
Wattage	21W
Part No.	WPS6063LED
Price (ea)	£17.95



Description	Lamp Assembly
Typical Application	Indicator, Rear
Colour	Clear
Lens Material	Plastic
H x W x D	77 x 73 x 40mm
Voltage	12V
Wattage	21W
Part No.	WPS6064LED
Price (ea)	£17.95



Description	Lamp Assembly
Typical Application	Stop & Tail
Colour	Clear
Lens Material	Plastic
H x W x D	78 x 73 x 40mm
Voltage	12V
Wattage	21/5W
Part No.	WPS6065LED
Price (ea)	£17.95

Lighting - FRONT SIDE & INDICATOR LAMPS

Lucas 632 Type

Round, side and flasher lamp, as used on Morris Minors & MGAs.



Description	Lamp Assembly
Colour	Amber/Clear
Lens Material	Plastic
H x W x D	95 x 95 x 40mm
Bulb Type	989 & 382
Voltage	12V
Wattage	5/21W
Part No.	13H6396
Price (ea)	£34.95



Description	Lamp Assembly
Colour	Clear/Clear
Lens Material	Plastic
H x W x D	95 x 95 x 40mm
Bulb Type	989 & 382
Voltage	12V
Wattage	5/21W
Part No.	13H520
Price (ea)	£31.96

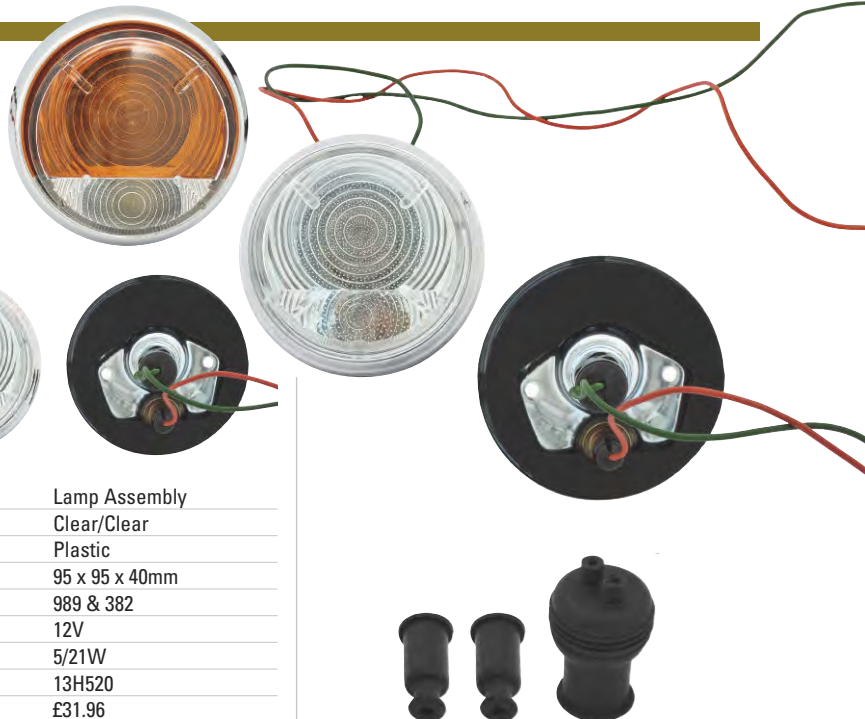

Replacement Parts: Lucas 632 type



Description	Contacts	Colour	Material	Part No	Price (ea)
1 Lens & Rim		Amber/Clear	Plastic	47H5507	£17.95
2 Lens & Rim		Clear/Clear	Plastic	47H5508	£13.45
3 Gasket Set, Lens				17H5307K	£6.80
4 Gasket, Lamp to Body				47H5505	£2.40
5 Contact Repair Kit	Single Contact			37H5452	£2.35
6 Contact Repair Kit	Twin Contact			37H5459	£4.75
7 Gaiter, Large				17H5216	£0.76
8 Gaiter, Small				37H5294	£0.95

Lucas 584 Type

As used on MG Midgets, features a clear outer lens with an amber inner cover for indicators.



Description	Lamp Assembly
Typical Application	Side & Indicator RH
Colour	Clear
Lens Material	Glass
H x W x D	152 x 62 x 40mm
Bulb Type	989 & 382
Voltage	12V
Wattage	5/21W
Part No.	13H429
Price (ea)	£32.95



Description	Lamp Assembly
Typical Application	Side & Indicator LH
Colour	Clear
Lens Material	Glass
H x W x D	152 x 62 x 40mm
Bulb Type	989 & 382
Voltage	12V
Wattage	5/21W
Part No.	13H428
Price (ea)	£32.95



Replacement Parts: Lucas 632 type

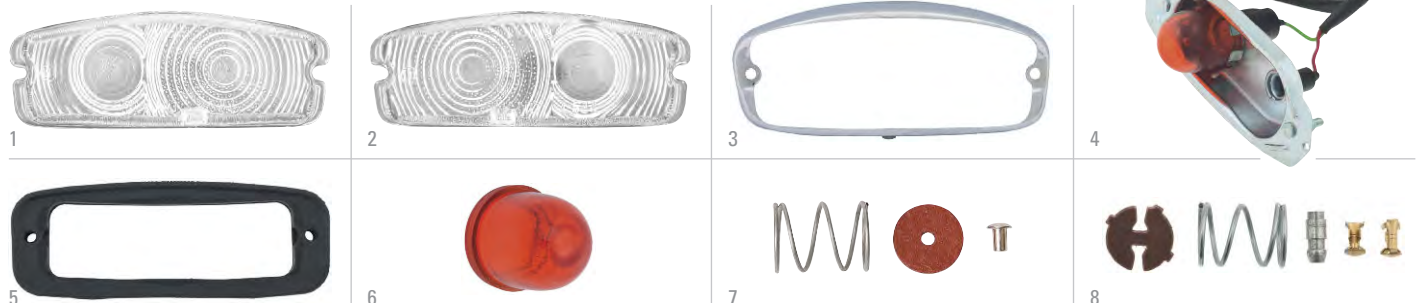

Description	Contact	Colour	Finish	Material	Part No	Price (ea)
1 Lens, LH		Clear		Glass	57H5159	£6.55
2 Lens, RH		Clear		Glass	57H5158	£6.55
3 Rim			Chrome		57H5155	£12.16
4 Base Plate					SML101	£22.40
5 Gasket				Rubber	57H5157	£3.65
6 Cover		Amber		Glass	57H5156	£7.40
7 Contact Repair Kit	Single Contact				37H5452	£2.35
8 Contact Repair Kit	Twin Contact				37H5459	£4.75
9 Gaiter, Large				Rubber	17H5216	£0.76
10 Gaiter, Small				Rubber	37H5294	£0.95



Lighting - FRONT SIDE & INDICATOR LAMPS

Lucas 677 Type

As used on MGBs, Triumph Spitfire MkIII & Aston Martin. Non-handed.

Description	Lamp Assembly
Colour	Amber/Clear
Lens Material	Plastic
H x W x D	61 x 150 x 40mm
Bulb Type	989 & 382
Voltage	12V
Wattage	5/21W
Part No.	BHA4966Z
Price (ea)	£13.96



Replacement Parts: Lucas 677 type

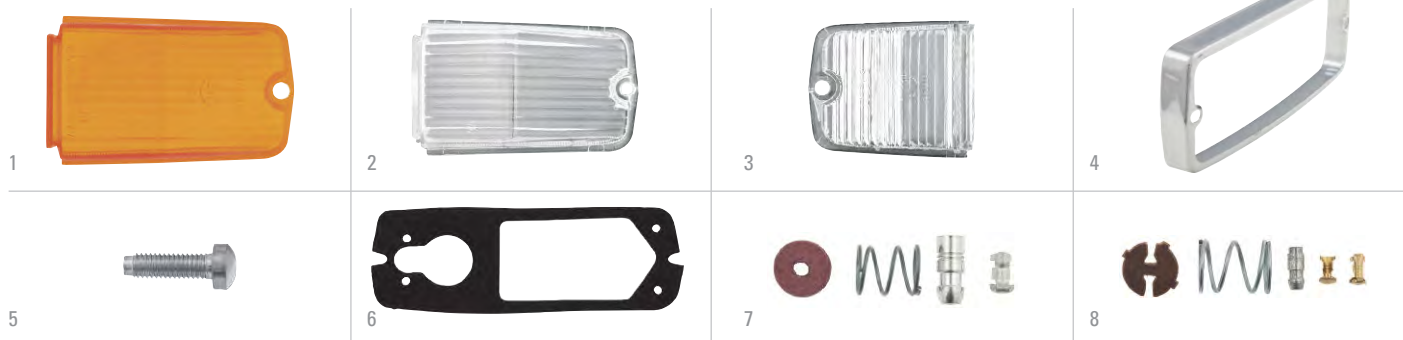

Description	Contact	Colour	Finish	Material	Part No	Price (ea)
1 Lens, Indicator		Amber		Plastic	516306	£3.65
2 Lens, Indicator		Clear		Plastic	516307	£3.90
3 Lens, Side Light		Clear		Plastic	516308	£5.56
4 Rim			Chrome		516304	£6.10
5 Screw, Rim to Base Plate					57H5569	£0.55
6 Gasket				Rubber	57H5572	£0.80
7 Contact Repair Kit	Single Contact				37H5452	£2.35
8 Contact Repair Kit	Twin Contact				37H5459	£4.75
9 Gaiter, Small				Rubber	37H5294	£0.95
10 Gaiter, Large				Rubber	17H5216	£0.76

Lucas 811 Type

As used on Mini Clubman & Lotus models.

Description	Lamp Assembly
Colour	Amber/Clear
Lens Material	Plastic
H x W x D	190 x 73 x 35mm
Bulb Type	989 & 382
Voltage	12V
Wattage	5/21W
Part No.	ADU3017A
Price (ea)	£83.95



Replacement Parts: Lucas 811 type



Description	Contact	Colour	Material	Part No	Price (ea)
1 Lens, Indicator		Amber/Clear	Plastic	BAU1796	£30.95
2 Contact Repair Kit	Single Contact			244700A	£1.45
3 Contact Repair Kit	Twin Contact			37H5459	£4.75

Lucas 1130 Type

As used on MG T Types and many other vintage cars with red illuminating 'King of the Road' medallion. Supplied with twin contact bulb holder. It can be used for most applications by wiring up the appropriate contact.

Description	Lamp Assembly
Colour	White
Lens Material	Glass
H x W x D	47 x 45 x 103mm
Bulb Type	170-900
Voltage	12V
Part No.	143-400
Price (ea)	£128.95

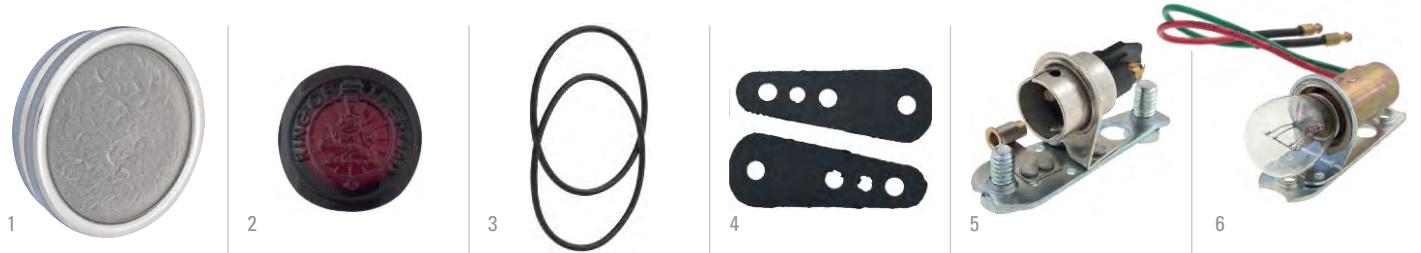
**Replacement Parts: Lucas 1130 type**

Description	Contacts	Colour	Material	Part No	Price (ea)
1 Lens, with Rim		White	Glass	157-750	£15.20
2 Medallion		Red	Plastic	154-900	£3.95
3 Seal, Lens			Rubber	281-088	£1.96
4 Gasket, Body			Rubber	281-068	£4.10
5 Bulb Holder	Twin Contact, Parallel Pins			157-600	£32.95
6 Bulb Holder	Twin Contact, Offset Pins			157-601	£29.95

Lucas 826 Type

As fitted to Triumph TR6.



Description	Lamp Assembly, LH
Colour	Amber
Lens Material	Plastic
H x W x D	107 x 73 x 21mm
Bulb Type	233
Voltage	12V
Wattage	4W
Part No.	152769
Price (ea)	£31.96



Description	Lamp Assembly, RH
Colour	Amber
Lens Material	Plastic
H x W x D	107 x 73 x 21mm
Bulb Type	233
Voltage	12V
Wattage	4W
Part No.	152768
Price (ea)	£31.96



Description	Lamp Assembly, Alternative
Colour	Amber
Lens Material	Plastic
H x W x D	107 x 73 x 21mm
Bulb Type	989
Voltage	12V
Wattage	5W
Part No.	152768/9Z
Price (ea)	£26.95

Replacement Parts: Lucas 826 type

Description	Contacts	Colour	Material	Part No	Price (ea)
1 Lens, LH		Amber	Plastic	518221Z	£5.95
2 Lens, RH		Amber	Plastic	518219Z	£5.95
3 Gasket, Lens			Rubber	518034X	£14.26
4 Contact Repair Kit	Single Contact			244700A	£1.45
5 Screw				PMP208	£0.40

Lighting - FRONT SIDE & INDICATOR LAMPS

Lucas 824 Type

These side markers were fitted to MGB's. They were available in amber for the UK and red for the USA 1970-90. LH & RH as fitted to an MGB.



Description	Lamp Assembly, RH
Colour	Amber
Material	Plastic
H x W x D	140 x 57 x 22mm
Bulb Type	989
Voltage	12V
Wattage	5W
Part No	BHA4968
Price (ea)	£49.96

Description	Lamp Assembly, LH
Colour	Amber
Material	Plastic
H x W x D	140 x 57 x 22mm
Bulb Type	989
Voltage	12V
Wattage	5W
Part No	BHA4969
Price (ea)	£49.96

Description	Lamp Assembly, RH
Colour	Red
Material	Plastic
H x W x D	140 x 57 x 22mm
Bulb Type	989
Voltage	12V
Wattage	5W
Part No	BHA4970
Price (ea)	£61.96

Description	Lamp Assembly, LH
Colour	Red
Material	Plastic
H x W x D	140 x 57 x 22mm
Bulb Type	989
Voltage	12V
Wattage	5W
Part No	BHA4971
Price (ea)	£61.96

Replacement Parts: Lucas 824 type



	Description	Colour	Material	Part No	Price (ea)
1	Lens, RH	Amber	Plastic	011727A	£13.50
2	Lens, LH	Amber	Plastic	011730A	£13.50
3	Lens, RH	Red	Plastic	37H4756	£16.94
4	Lens, LH	Red	Plastic	37H4757	£16.94
5	Plinth, Front RH		Plastic	AHH9964	£4.85
6	Plinth, Front LH		Plastic	AHH9965	£4.85
7	Plinth, Rear RH		Plastic	AHH9966	£4.85
8	Plinth, Rear LH		Plastic	AHH9967	£4.85
9	Gasket, Lens		Rubber	37H4753	£0.95

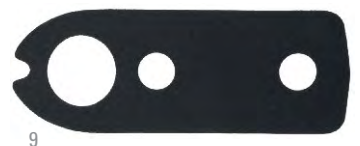

Lighting - NUMBER PLATE LAMPS

Lucas 467 Type



Description	Lamp Assembly, High Quality
Finish	Chrome
Cover Material	Metal
Lens Material	Glass
H x W x D	43 x 107 x 35mm
Bulb Type	989
Voltage	12V
Wattage	5W
Part No.	127916X
Price (ea)	£38.56



Description	Lamp Assembly, Good Quality
Finish	Chrome
Cover Material	Metal
Lens Material	Glass
H x W x D	52 x 113 x 42mm
Bulb Type	989
Voltage	12V
Wattage	5W
Part No.	127916
Price (ea)	£20.95



Description	Lamp Assembly
Finish	Chrome
Cover Material	Plastic
Lens Material	Plastic
H x W x D	47 x 110 x 36mm
Bulb Type	989
Voltage	12V
Wattage	5W
Part No.	127916Z
Price (ea)	£13.96



Description	Lamp Assembly
Colour	Black
Cover Material	Metal
Lens Material	Glass
H x W x D	51 x 113 x 42mm
Bulb Type	989
Voltage	12V
Wattage	5W
Part No.	127916BLK
Price (ea)	£20.95

Replacement Parts: Lucas 476 type



Description	Colour	Finish	Material	Part No	Price (ea)
1 Cover		Chrome	Metal	502264	£9.16
2 Cover	Black		Plastic	502264BLK	£9.46
3 Lens	Clear		Glass	601721A	£4.20
4 Gasket, lens & base plate			Rubber	57H5368	£2.95
5 Screw		Chrome		17H5385	£1.66



Lighting - NUMBER PLATE LAMPS

Lucas 534 Type

Chrome plated number plate lamp for mounting on flat surfaces, also suitable for a dash mounted map light.



Description	Lamp & Plinth Assembly
Finish	Chrome
Lens Material	Glass
H x W x D	45 x 67 x 43mm
Bulb Type	989
Voltage	12V
Wattage	5W
Part No.	2A9119
Price (ea)	£33.95



Description	Lamp Kit, no Base Plate
Finish	Chrome
Lens Material	Glass
H x W x D	35 x 60 x 30mm
Bulb Type	207
Voltage	12V
Wattage	5W
Part No.	BHA4283
Price (ea)	£12.95



Replacement Parts: Lucas 534 type



Description	Contact	Colour	Material	Part No	Price (ea)
1 Lens		Clear	Glass	606078A	£6.25
2 Contact Repair Kit	Single Contact			244700A	£1.45
3 Gaiter, Small			Rubber	37H5294	£0.95
4 Gasket			Rubber	17H5302	£2.10

Lucas 550 Type

Compact chrome plated round bodied lamp, as used on TR5 overrides.



Description	Lamp Assembly, High Quality
Finish	Chrome
Lens Material	Glass/Clear
H x W x D	33 x 33 x 21mm
Bulb Type	207
Voltage	12V
Wattage	5W
Part No.	142002
Price (ea)	£20.95



Description	Lamp Assembly, Good Quality
Finish	Chrome/Clear
Lens Material	Plastic
H x W x D	33 x 33 x 21mm
Bulb Type	207
Voltage	12V
Wattage	5W
Part No.	142002Z
Price (ea)	£10.15



Replacement Parts: Lucas 550 type

Description	Contact	Finish	Colour	Material	Part No	Price (ea)
1 Cover		Chrome			131465A	£10.15
2 Lens			Clear	Glass	510875A	£5.45
3 Contact Repair Kit	Single Contact				37H5452	£2.35



Lucas 766 Type

Long, bumper mounted lamp assembly with twin bulbs. As used on Triumph TR6, Stag & Spitfire.

Description	Lamp Assembly, Plain
Finish	Chrome/Clear
Lens Material	Plastic
H x W x D	45 x 315 x 45mm
Bulb Type	207
Voltage	12V
Wattage	5W
Part No.	151954
Price (ea)	£109.96

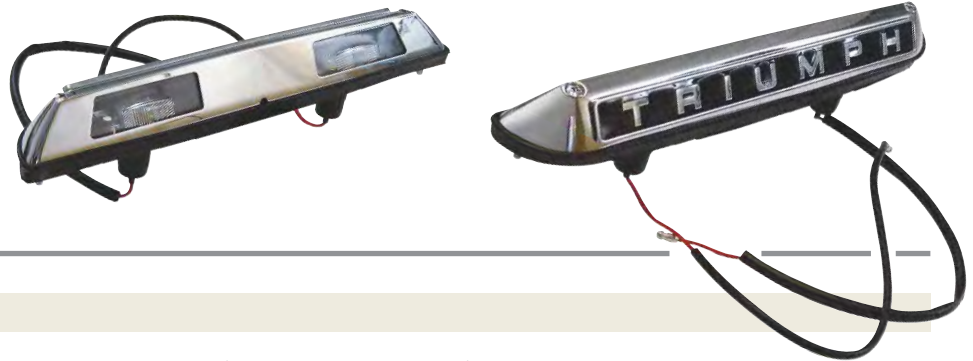

Description	Lamp Assembly, Triumph
Finish	Chrome
Lens Material	Plastic
H x W x D	45 x 310 x 45mm
Bulb Type	207
Voltage	12V
Wattage	5W
Part No.	718028
Price (ea)	£119.95

**Replacement Parts: Lucas 766 type**

	Description	Contact	Finish	Material	Part No	Price (ea)
1	Cover, Plain		Chrome		518030	£44.00
2	Lens, LH			Plastic	518031	£10.96
3	Lens, RH			Plastic	518032	£10.96
4	Gaiter			Rubber	215823	£15.90
5	Contact Repair Kit	Single Contact			37H5452	£2.35

Lucas 525 Type

Rear Number plate lamp for early TR, Lotus MK IX, also suits motorcycles.



Description	Lamp Assembly
Colour	Red/Clear
Lens Material	Plastic
H x W x D	110 x 50 x 47mm
Bulb Type	380
Voltage	12V
Wattage	21/5W
Part No.	109497
Price (ea)	£34.76

Replacement Parts: Lucas 525 type

	Description	Contact	Material	Part No	Price (ea)
1	Contact Repair Kit	Twin Contact		37H5459	£4.75

Lighting - INTERIOR LAMPS

Interior Light

Interior lamp with white plastic cover. As used on Classic Minis, MGBs etc.



Description	Lamp Assembly, with switch
Mounting Type	Surface
Colour	White
Lens Material	Plastic
H x W x D	45 x 108 x 38mm
Bulb Type	239
Voltage	12V
Wattage	5W
Part No.	EAM1650
Price (ea)	£9.80

Replacement Parts



Description	Replacement Lens
Colour	White
Lens Material	Plastic
Part No.	24G3389
Price (ea)	£6.46

Interior Light

Long style lamp with chrome cover & plastic base. As used on MGBs, TRs etc.



Description	Lamp Assembly, with switch
Mounting Type	Surface
Colour	Clear
Lens Material	Plastic
H x W x D	31 x 121 x 14mm
Bulb Type	239
Voltage	12V
Wattage	5W
Part No.	BHA5138
Price (ea)	£11.95

Replacement Parts



Description	Replacement Lens
Colour	Clear
Lens Material	Plastic/Chrome
Part No.	27H3590
Price (ea)	£9.25

Boot Lamp

Interior boot lamp. As used on TRs, Spitfires etc. Suitable for use in various applications. Requires a hole to be cut in trim panel.

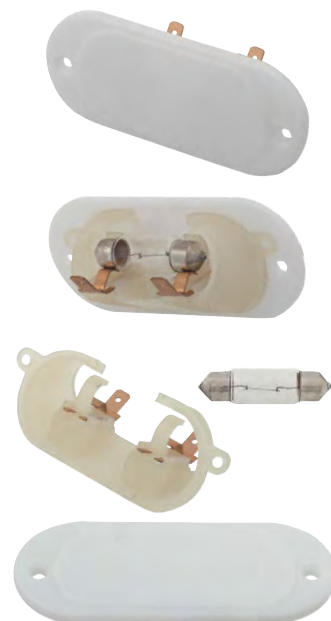

Description	Lamp Assembly
Mounting Type	Recess
Colour	White
Lens Material	Plastic
H x W x D	34 x 83 x 3mm
Bulb Type	239
Voltage	12V
Wattage	5W
Part No.	151353
Price (ea)	£5.95

Boot Lamp

As used on MGBs, Late Sprites & Midgets.



Description	Lamp Assembly
Mounting Type	Surface
Colour	White
Lens Material	Plastic
H x W x D	38 x 122 x 35mm
Bulb Type	239
Voltage	12V
Wattage	5W
Part No.	BHA5040
Price (ea)	£7.96

Lighting - REVERSE LAMPS

Lucas 798 Type

As fitted to MGB & Midget.



Description	Lamp Assembly
Mounting Type	Hole
Colour	Clear
Lens Material	Plastic
H x W x D	64 x 75 x 16mm
Bulb Type	273
Voltage	12V
Wattage	21W
Part No.	AAU5510
Price (ea)	£10.96



Description	Rim Kit*
Material	Chrome
Part No.	37H7512CRK
Price (pair)	£24.95

*Includes 2 x lenses, 2 x chrome rims, 2 x lens gaskets and necessary fittings.

Auxiliary Reverse Lamp

Universal polished stainless steel reverse lamps.



Description	Auxiliary Reverse Lamp
Colour	Clear
Lens Material	Glass
H x W x D	55 x 110 x 65mm
Bulb Type	GAC4608B
Voltage	12V
Part No.	GAC4609
Price (ea)	£17.95

Replacement Parts: Lucas 798 type



	Description	Material	Part No	Price (ea)
1	Lens, Good Quality	Plastic	37H7512	£5.95
2	Lens, Alternative	Plastic	37H7512Z	£3.95
3	Gasket	Rubber	37H1759	£0.55
4	Rim, Chrome	Chrome	37H7512CR	£8.40

Lighting - REFLECTORS



Description	Reflector
Fixing	Centre Screw Fixing
Colour	Red
Surround	N/A
Lens Material	Plastic
Shape	Round
H x W x D	55 x 55 x 10mm
Part No.	501485
Price (ea)	£11.35



Description	Reflector
Fixing	Centre Screw Fixing
Colour	Red
Surround	Chrome
Lens Material	Plastic
Shape	Round
H x W x D	52 x 52 x 16mm
Part No.	144-700
Price (ea)	£12.95



Description	Reflector
Fixing	Centre Screw Fixing
Colour	Red
Surround	Black Rubber
Lens Material	Plastic
Shape	Round
H x W x D	74 x 74 x 28mm
Part No.	144-600
Price (ea)	£14.80



Description	Reflector
Fixing	Bolt Centre Fixing
Colour	Red
Surround	Chrome
Lens Material	Plastic
Shape	Round
H x W x D	72 x 72 x 11mm
Part No.	BCA4871
Price (ea)	£13.15



Description	Reflector
Fixing	Side Screw Fixing
Colour	Red
Surround	Chrome
Lens Material	Plastic
Shape	Rectangular
H x W x D	88 x 40 x 5mm
Part No.	BCA4568
Price (ea)	£17.75

Lighting - STOP & TAIL LAMP ASSEMBLIES

Lucas 676 Type

As fitted to early MG Midgets and MGBs.

Description	Lamp Assembly
Colour	Red/Amber
Lens Material	Plastic
H x W x D	97 x 300 x 65mm
Bulb Type	382 & 380
Voltage	12V
Wattage	21/5W
Part No.	BHA4175
Price (ea)	£54.95



Replacement Parts: Lucas 676 type



Description	Contact	Finish	Colour	Material	Part No	Price (ea)
1 Lens, Indicator			Amber	Plastic	57H5354	£5.35
2 Lens, Stop/Tail			Red	Plastic	57H5357	£7.94
3 Gasket, Lens				Rubber	57H5356	£0.95
4 Gasket, Lamp				Rubber	57H5358	£0.95
5 Bezel		Chrome			57H5355	£11.15
6 Terminal Kit	Single Contact				37H5452	£2.35
7 Terminal Kit	Twin Contact				37H5459	£4.75
8 Boot, Lead & Holder					17H5216	£0.76

Lucas 840 Type

As used on later MG Midgets and MGBs.

Description	Lamp Assembly
Colour	Red/Amber
Lens Material	Plastic
H x W x D	102 x 300 x 79mm
Bulb Type	382 & 380
Voltage	12V
Wattage	21/5W
Part No.	BHA4973
Price (ea)	£56.95



Replacement Parts: Lucas 840 type

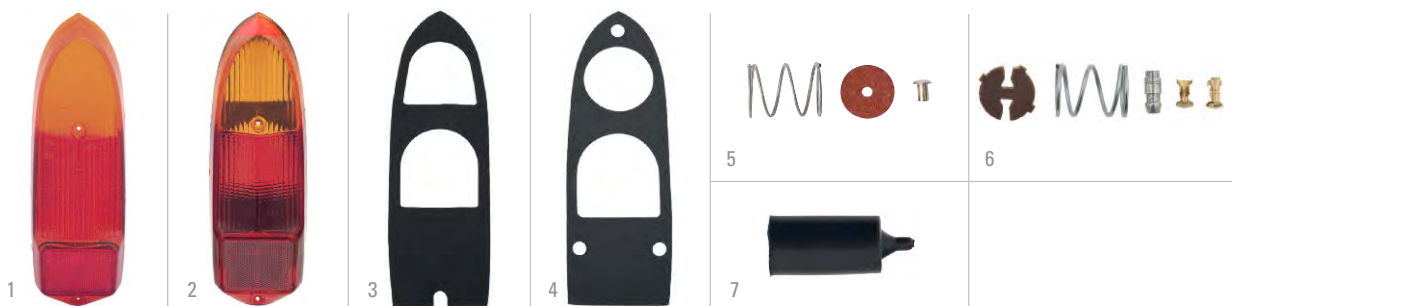

Description	Contact	Colour	Material	Part No	Price (ea)
1 Lens		Red/Amber	Plastic	37H4737	£13.50
2 Lens, Alternative		Red/Amber	Plastic	37H4737Z	£12.46
3 Gasket, Lens			Foam	37H4737A	£1.25
4 Gasket, Lamp			Foam	37H4679	£0.95
5 Terminal Kit	Single Contact			37H5452	£2.35
6 Terminal Kit	Twin Contact			37H5459	£4.75
7 Boot, Lead & Holder			Rubber	17H5216	£0.76

Lucas 669 Type

As fitted to Triumph TR4, 4A, 5 and Aston Martin DB6.



Description	Lamp Assembly
Colour	Red
Lens Material	Plastic
H x W x D	250 x 95 x 37mm
Bulb Type	382 & 380
Voltage	12V
Wattage	21/5W
Part No.	208207Z
Price (ea)	£119.95

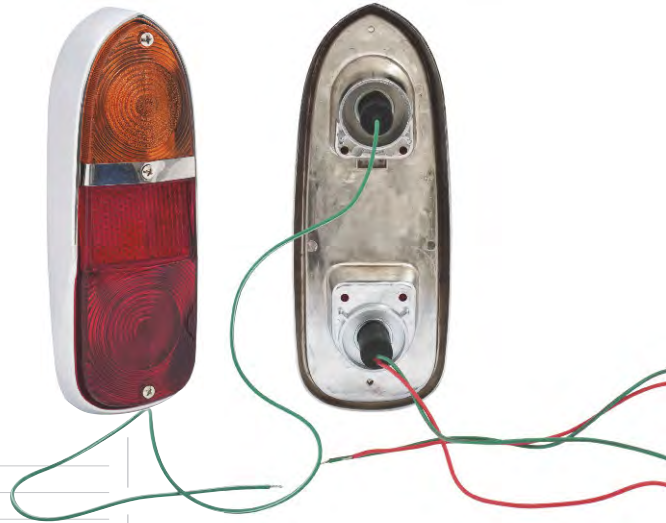
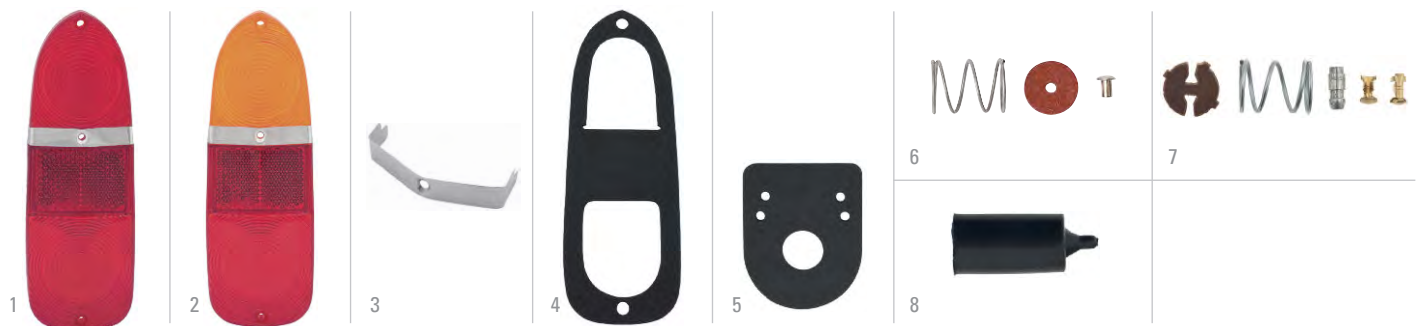

Description	Lamp Assembly
Colour	Red/Amber
Lens Material	Plastic
H x W x D	250 x 95 x 37mm
Bulb Type	382 & 380
Voltage	12V
Wattage	21/5W
Part No.	208208Z
Price (ea)	£119.95

**Replacement Parts: Lucas 669 type**

	Description	Contact	Finish	Colour	Material	Part No	Price (ea)
1	Lens			Red	Plastic	516061	£17.30
2	Lens			Red/Amber	Plastic	516040	£11.95
3	Finishing Strip		Chrome			510903	£0.85
4	Gasket, Lens				Foam	510906	£3.16
5	Gasket, Lamp				Foam	133364	£1.80
6	Terminal Kit	Single Contact				37H5452	£2.35
7	Terminal Kit	Twin Contact				37H5459	£4.75
8	Grommet				Rubber	17H5216	£0.76

Lucas 647 Type

As fitted to Mini Mk1. Also fitted to MGAs with the opposite LH/RH application.



Description	Lamp Assembly, LH
Colour	Red/Amber
Lens Material	Plastic
H x W x D	180 x 80 x 55mm
Bulb Type	382 & 380
Voltage	12V
Wattage	21/5W
Part No.	BHA4229
Price (ea)	£49.96



Description	Lamp Assembly, RH
Colour	Red/Amber
Lens Material	Plastic
H x W x D	180 x 80 x 55mm
Bulb Type	382 & 380
Voltage	12V
Wattage	21/5W
Part No.	BHA4228
Price (ea)	£49.96

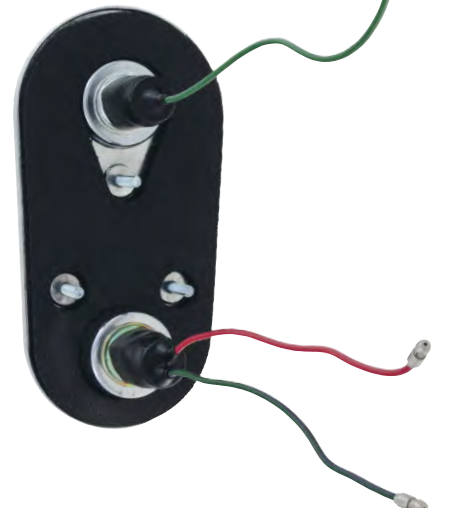

Lighting - STOP & TAIL LAMP ASSEMBLIES

Replacement Parts: Lucas 647 type

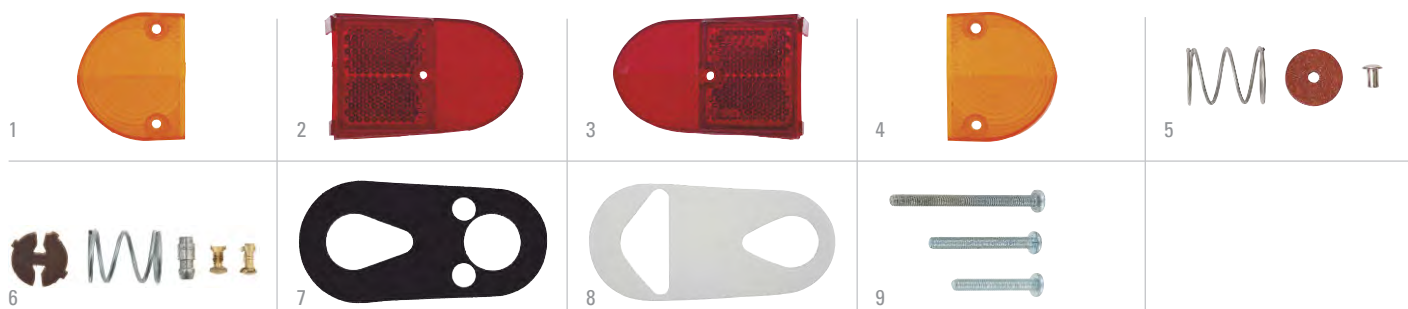

Description	Contact	Colour	Material	Part No	Price (ea)
1 Lens, Indicator, LH		Amber	Plastic	47H5355	£7.96
2 Lens, Stop/Tail, LH		Red	Plastic	47H5358	£9.65
3 Lens, Stop/Tail, RH		Red	Plastic	47H5363	£9.65
4 Lens, Indicator, RH		Amber	Plastic	47H5362	£7.96
5 Terminal Kit	Single Contact			37H5452	£2.35
6 Terminal Kit	Twin Contact			37H5459	£4.75
7 Gasket, Lamp				57H5399	£2.15
8 Gasket, Lens				47H5360	£2.45
9 Screw Set				47H5356K	£7.96

Lucas 813 Type

As fitted to Mini MKII.



Description	Lamp Assembly, LH
Colour	Red/Amber
Lens Material	Plastic
H x W x D	220 x 110 x 55mm
Bulb Type	382 & 380
Voltage	12V
Wattage	21/5W
Part No.	13H6480
Price (ea)	£46.96

Description	Lamp Assembly, RH
Colour	Red/Amber
Lens Material	Plastic
H x W x D	220 x 110 x 55mm
Bulb Type	382 & 380
Voltage	12V
Wattage	21/5W
Part No.	13H6479
Price (ea)	£46.96

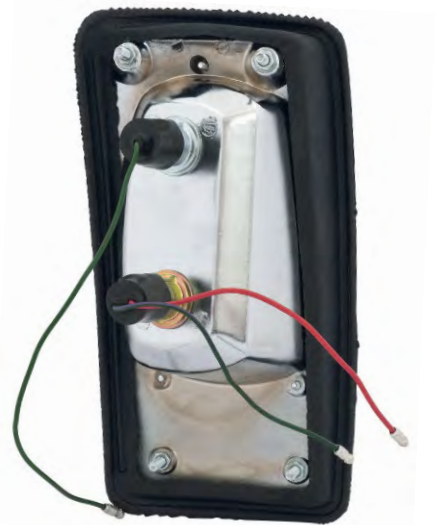

Replacement Parts: Lucas 813 type



Description	Colour	Material	Part No	Price (ea)
1 Lens, LH	Red/Amber	Plastic	37H4837	£20.40
2 Lens, RH	Red/Amber	Plastic	37H4838	£20.40
3 Seal, Lamp, LH		Rubber	37H2689	£8.15
4 Seal, Lamp, RH		Rubber	37H2690	£8.15
5 Seal, Lens		Foam	37H6778	£1.50

Lucas 940 Type

As fitted to Mini MkIII on.



Description	Lamp Assembly, LH
Colour	Red/Amber/Clear
Lens Material	Plastic
H x W x D	243 x 132 x 92mm
Bulb Type	382 & 380
Voltage	12V
Wattage	21/5W
Part No.	XFB10083
Price (ea)	£94.96

Description	Lamp Assembly, RH
Colour	Red/Amber/Clear
Lens Material	Plastic
H x W x D	243 x 132 x 92mm
Bulb Type	382 & 380
Voltage	12V
Wattage	21/5W
Part No.	XFB10082
Price (ea)	£94.96

Replacement Parts: Lucas 940 type

Description	Colour	Material	Part No	Price (ea)
1 Lens, Stop & Indicator, LH	Red/Amber	Plastic	XFJ10027	£17.95
2 Lens, Reverse, LH	Clear/Red Reflector	Plastic	XFJ10029	£13.96
3 Seal, Lamp, LH		Rubber	37H2691	£9.95
4 Lens, Stop & Indicator, RH	Red/Amber	Plastic	XFJ10026	£17.95
5 Lens, Reverse, RH	Clear/Red Reflector	Plastic	XFJ10028	£13.96
6 Seal, Lamp, RH		Rubber	37H2692	£9.95
7 Seal, Lens		Foam	XFH100460	£2.75

Lucas 672 Type

As fitted to Triumph Spitfire Mk I, II and III and GT6. Also used on Kit Cars.



Description	Lamp Assembly
Colour	Red
Lens Material	Plastic
H x W x D	137 x 78 x 80mm
Bulb Type	380
Voltage	12V
Wattage	21/5W
Part No.	217025
Price (ea)	£60.95

Replacement Parts: Lucas 672 type

Description	Colour	Material	Part No	Price (ea)
1 Lens	Red	Plastic	511800	£9.60
2 Gasket, Lens		Foam	511802	£1.50
3 Gasket, Lamp		Rubber	AJA5073	£2.45
4 Screw		Plastic	PMP308	£0.40

Lighting - STOP & TAIL LAMP ASSEMBLIES

Lucas 549 Type

As fitted to Morgan, TR, MGA, Morris Minor etc.

Description	Lamp Assembly
Colour	Red
Lens Material	Plastic
H x W x D	79 x 137 x 73mm
Bulb Type	380
Voltage	12V
Wattage	21/5W
Part No.	13H23
Price (ea)	£19.94

**Replacement Parts: Lucas 549 type**

Description	Finish	Material	Part No	Price (ea)
1 Base Plate	Chrome		AJA5072	£17.50
2 Gasket, Lamp to Plinth		Rubber	AJA5073	£2.45
3 Gasket, Lens		Foam	AJA5071	£1.94
4 Screw	Chrome		57H5569	£0.55

Mounting Plinth for Lucas 549 lamps

Designed to suit the curve of the MGA's rear wing these plinths can be modified to follow other panel shapes.

Description	Plinth
Material	Alloy
Part No.	AHH5393
Price (ea)	£67.96

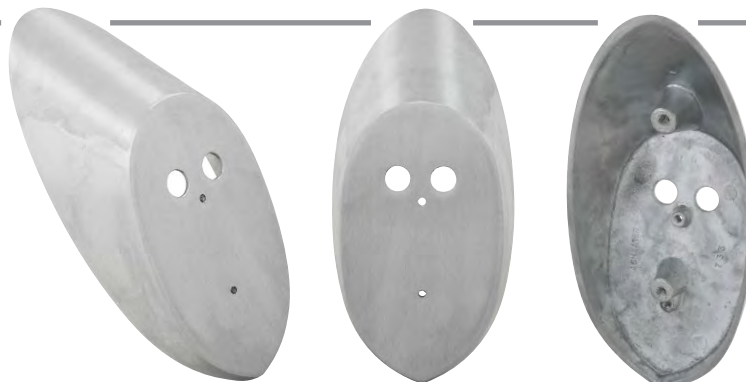
**Lucas 471 Type**

As fitted to early MG TD models these lamps can also be fitted to any similar sloping rear wing. Supplied with double contact bulb for rear and brake light, glass lens, chromed rim, gaskets & fitting screws.

Description	Lamp Assembly
Colour	Red
Lens Material	Glass
H x W x D	120 x 65 x 55mm
Bulb Type	380
Voltage	12V
Wattage	21/5W
Part No.	157-908
Price (ea)	£64.96

**Replacement Parts: Lucas 471 type**

Description	Finish	Colour	Material	Part No	Price (ea)
1 Screw	Chrome			157-800	£4.25
2 Rim	Chrome			157-920	£11.75
3 Lens		Red	Glass	501934X	£12.25
4 Plate & Holder				158-310	£29.95
5 Body				280-510	£8.95

Lucas ST38 Type

Vintage 'pork pie' rear lamp. Rear lamp, brake lamp and number plate lamp, as used on the MG T-Type.

Description	Lamp Assembly
Finish	Black
Colour	Red
Lens Material	Glass/Plastic
H x W x D	90 x 63mm
Bulb Type	207
Voltage	12V
Wattage	5W
Part No.	143-890
Price (ea)	£64.96

**Lucas ST51 Type**

Chrome 'D' Lamp. Stop, tail and number plate lamp, as used on the MG T-Type.

Description	Lamp Assembly
Finish	Black
Colour	Red
Lens Material	Glass/Plastic
H x W x D	90 x 63mm
Bulb Type	207
Voltage	12V
Wattage	5W
Part No.	143-900
Price (ea)	£89.95

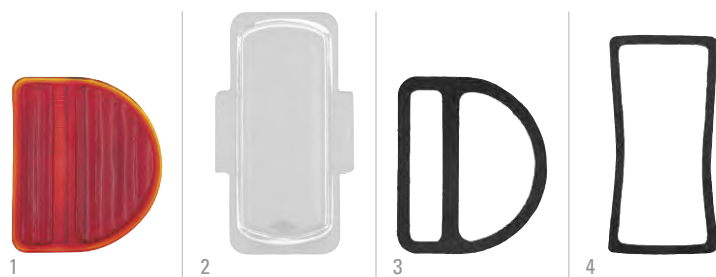
**Replacement Parts: Lucas ST51 type**

Description	Finish	Colour	Material	Part No	Price (ea)
1 Lens, Split 'D'		Red	Glass	154-600	£11.35
2 Lens, Side		Clear	Glass	143-920	£9.89
3 Gasket, Split 'D' Lens			Rubber	143-940	£2.26
4 Gasket, Lens			Rubber	143-930	£2.95

Rear Turn Signal

As used on MG TC models that were exported to the USA up to 1949 as a rear turn signal lamp.

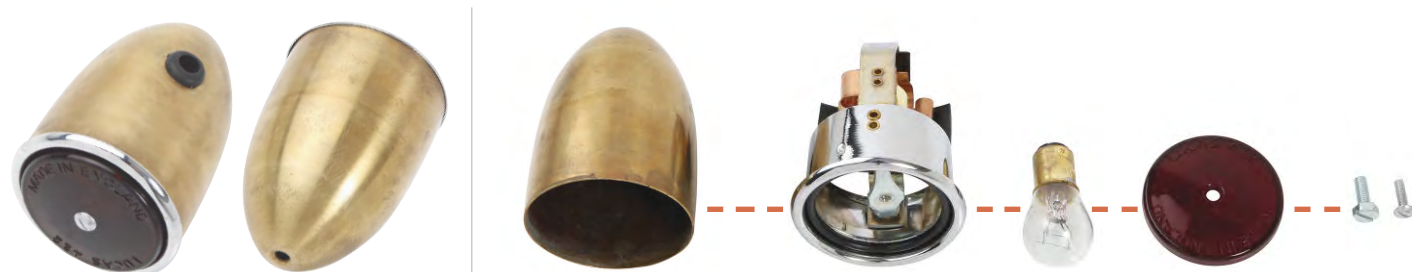

Description	Lamp Assembly
Application	Rear Turn Signal
Colour	Red
Lens Material	Plastic
Part No.	143-975
Price (ea)	£179.95

Lighting - BULBS

BPF Headlamp Bulbs



Bulb Type	BPF
Fitting	P36d
Volts	12
Watts	45/40
Length	64
Glass Dia	28
Cap Dia	36
Colour	Clear
RHD/LHD	RHD
Dips	Vertical
Reference	370
Part No	GLB370
Price (ea)	£8.38



Bulb Type	BPF
Fitting	P36d
Volts	12
Watts	50/40
Length	64
Glass Dia	28
Cap Dia	36
Colour	Clear
RHD/LHD	RHD
Dips	LH Dip
Reference	414
Part No	GLB414
Price (ea)	£4.94



Bulb Type	BPF
Fitting	P36d
Volts	12
Watts	50/40
Length	64
Glass Dia	28
Cap Dia	36
Colour	Clear
RHD/LHD	LHD
Dips	RH Dip
Reference	415
Part No	GLB415
Price (ea)	£7.66

UEC Headlamp Bulbs



Bulb Type	UEC
Fitting	P45T
Volts	12
Watts	45/40
Length	70
Glass Dia	36
Cap Dia	44
Pin Position	N/A
Colour	Clear
Type	Filament
Contacts/ Circuits	Twin
RHD/LHD	LHD
Dips	RH Dip
Reference	410
Part No	GLB410
Price (ea)	£2.60



Bulb Type	UEC
Fitting	P45T
Volts	12
Watts	60/55
Length	76
Glass Dia	16
Cap Dia	44
Pin Position	N/A
Colour	Clear
Type	Filament
Contacts/ Circuits	Twin
RHD/LHD	LHD
Dips	RH Dip
Reference	2983
Part No	GLB2983
Price (ea)	£8.26

Halogen 'Type' Headlamp Bulbs



Fitting	H1
Bulb Type	Halogen
Volts	12
Output (Watts)	55
Length	67.5
Glass Dia	8.5
Cap Dia	24
Colour	Clear
Reference	448
Part No	GLB448
Price (ea)	£4.45



Fitting	H1
Bulb Type	Xenon
Volts	12
Output (Watts)	55
Length	67.5
Glass Dia	8.5
Cap Dia	24
Colour	Clear
Reference	448
Part No	GLB448X
Price (ea)	£4.96



Fitting	H2
Bulb Type	Halogen
Volts	12
Output (Watts)	55
Length	31
Glass Dia	9
Cap Dia	19.5
Colour	White
Reference	479
Part No	GLB479
Price (ea)	£3.85



Fitting	H3
Bulb Type	Halogen
Volts	12
Output (Watts)	55
Length	42
Glass Dia	11.5
Cap Dia	22
Colour	Clear
Reference	453
Part No	GLB453
Price (ea)	£3.60



Fitting	H3
Bulb Type	Xenon
Volts	12
Output (Watts)	55
Length	42
Glass Dia	11.5
Cap Dia	22
Colour	Clear
Reference	453
Part No	GLB453X
Price (ea)	£8.56



Fitting	H4
Bulb Type	Halogen
Volts	12
Output (Watts)	60/55
Length	77
Glass Dia	15.5
Cap Dia	43
Colour	White
Reference	472
Part No	GLB472
Price (ea)	£3.84

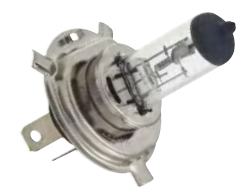

Fitting	H4
Bulb Type	Halogen
Volts	12
Output (Watts)	100/80
Length	77
Glass Dia	15.5
Cap Dia	43
Colour	White
Reference	472
Part No	GLB484
Price (ea)	£5.75



Fitting	H4
Bulb Type	Xenon
Volts	12
Output (Watts)	60/55
Length	77
Glass Dia	15.5
Cap Dia	43
Colour	Blue
Reference	472
Part No	GLB472BLU
Price (ea)	£8.35



Fitting	H4
Bulb Type	Xenon
Volts	12
Output (Watts)	60/55
Length	77
Glass Dia	15.5
Cap Dia	43
Colour	White
Reference	472
Part No	GLB472X
Price (ea)	£8.45



Fitting	H7
Bulb Type	Halogen
Volts	12
Output (Watts)	55
Length	58
Glass Dia	10.5
Cap Dia	34
Colour	White
Reference	499
Part No	GLB499
Price (ea)	£7.85

Bayonet Bulbs - BA15



Bulb Type	Bayonet
Fitting	BA15d
Volts	12
Length	47
Glass Dia	25
Cap Dia	15
Pin Position	Stepped
Output (Watts)	21/5
Colour	Clear
Contacts/	Twin
Circuits	
Reference	380
Part No	GLB380
Price (ea)	£0.46



Bulb Type	Bayonet
Fitting	BA15d
Volts	12
Length	47
Glass Dia	25
Cap Dia	15
Pin Position	Stepped
Output (Watts)	21/5
Colour	Red
Contacts/	Twin
Circuits	
Reference	380
Part No	GLB380R
Price (ea)	£1.96



Bulb Type	Bayonet
Fitting	BAZ15d
Volts	12
Length	47
Glass Dia	25
Cap Dia	15
Pin Position	Offset
Output (Watts)	21/4
Colour	Clear
Contacts/	Twin
Circuits	
Reference	566
Part No	GLB566
Price (ea)	£0.95



Bulb Type	Bayonet
Fitting	BA15s
Volts	12
Length	37.5
Glass Dia	16
Cap Dia	15
Pin Position	Straight
Output (Watts)	5
Colour	Clear
Contacts/	Single
Circuits	
Reference	207
Part No	GLB207
Price (ea)	£0.50



Bulb Type	Bayonet
Fitting	BA15s
Volts	12
Length	37.5
Glass Dia	16
Cap Dia	15
Pin Position	Straight
Output (Watts)	10
Colour	Clear
Contacts/	Single
Circuits	
Reference	2045
Part No	GLB245
Price (ea)	£0.76

Bayonet Bulbs - BA9



Bulb Type	Bayonet
Fitting	BA15s
Volts	12
Length	47
Glass Dia	25
Cap Dia	15
Pin Position	Straight
Output (Watts)	21
Colour	Amber
Contacts/	Single
Circuits	
Reference	343
Part No	GLB343
Price (ea)	£1.75



Bulb Type	Bayonet
Fitting	BA15s
Volts	12
Length	47
Glass Dia	25
Cap Dia	15
Pin Position	Straight
Output (Watts)	21
Colour	Clear
Contacts/	Single
Circuits	
Reference	382
Part No	GLB382
Price (ea)	£0.55



Bulb Type	Bayonet
Fitting	BA9s
Volts	12
Length	24
Glass Dia	10
Cap Dia	9
Pin Position	Straight
Output (Watts)	2.2
Colour	Clear
Contacts/	Single
Circuits	
Reference	643
Part No	GLB643
Price (ea)	£0.66



Bulb Type	Bayonet
Fitting	BA9s
Volts	12
Length	26
Glass Dia	8.5
Cap Dia	9
Pin Position	Straight
Output (Watts)	4
Colour	Clear
Contacts/	Single
Circuits	
Reference	233
Part No	GLB233
Price (ea)	£0.58



Bulb Type	Bayonet
Fitting	BA9s
Volts	12
Length	26
Glass Dia	15
Cap Dia	9
Pin Position	Straight
Output (Watts)	5
Colour	Clear
Contacts/	Single
Circuits	
Reference	989
Part No	GLB989
Price (ea)	£0.65

Bayonet Bulbs - BA7



Bulb Type	Bayonet
Fitting	BA7s
Volts	12
Length	20
Glass Dia	7
Cap Dia	7
Pin Position	Straight
Output (Watts)	1.2
Colour	Clear
Contacts/	Single
Circuits	
Reference	284
Part No	GLB284
Price (ea)	£0.95



Bulb Type	Bayonet
Fitting	BA7s
Volts	12
Length	20
Glass Dia	7
Cap Dia	7
Pin Position	Straight
Output (Watts)	2
Colour	Clear
Contacts/	Single
Circuits	
Reference	281
Part No	GLB281
Price (ea)	£0.95

Screw Bulbs - MES



Bulb Type	Screw
Fitting	E5
Volts	12
Length	16
Glass Dia	6
Cap Dia	5
Output (Watts)	0.75
Colour	Clear
Contacts/	Single
Circuits	
Reference	921
Part No	GLB921
Price (ea)	£1.15



Bulb Type	Screw
Fitting	E5
Volts	12
Length	16
Glass Dia	6
Cap Dia	5
Output (Watts)	1.5
Colour	Clear
Contacts/	Single
Circuits	
Reference	280
Part No	GLB280
Price (ea)	£1.25



Bulb Type	Screw
Fitting	E10
Volts	12
Length	23
Glass Dia	11
Cap Dia	10
Output (Watts)	2.2
Colour	Clear
Contacts/	Single
Circuits	
Reference	987
Part No	GLB987
Price (ea)	£0.46

Lighting - BULBS

Festoon Bulbs



Bulb Type	Festoon
Fitting	SV6
Volts	12
Length	36
Glass Dia	6
Cap Dia	6
Output (Watts)	3
Colour	Clear
Contacts/ Circuits	Single
Reference	256
Part No	GLB256
Price (ea)	£1.94



Bulb Type	Festoon
Fitting	SV8.5
Volts	12
Length	36
Glass Dia	11
Cap Dia	8.5
Output (Watts)	5
Colour	Clear
Contacts/ Circuits	Single
Reference	239
Part No	GLB239
Price (ea)	£0.60



Bulb Type	Festoon
Fitting	SV8.5
Volts	12
Length	36
Glass Dia	11
Cap Dia	8.5
Output (Watts)	10
Colour	Clear
Contacts/ Circuits	Single
Reference	272
Part No	GLB272
Price (ea)	£1.55



Bulb Type	Festoon
Fitting	SV8.5
Volts	12
Length	42
Glass Dia	15
Cap Dia	8.5
Output (Watts)	21
Colour	Clear
Contacts/ Circuits	Single
Reference	273
Part No	GLB273
Price (ea)	£0.76

Capless 'Wedge' Bulbs



Bulb Type	Capless
Fitting	W2 x 4.6d
Volts	12
Length	20
Glass Dia	5
Output (Watts)	1.2
Colour	Clear
Contacts/ Circuits	Single
Reference	286
Part No	GLB286
Price (ea)	£0.95



Bulb Type	Capless
Fitting	W2 x 4.6d
Volts	12
Length	20
Glass Dia	5
Output (Watts)	2
Colour	Clear
Contacts/ Circuits	Single
Reference	924
Part No	GLB924
Price (ea)	£0.95



Bulb Type	Capless
Fitting	W2.1 x 9.5d
Volts	12
Length	28
Glass Dia	10
Output (Watts)	2
Colour	Clear
Contacts/ Circuits	Single
Reference	297
Part No	GLB297
Price (ea)	£1.36



Bulb Type	Capless
Fitting	W2.1 x 9.5d
Volts	12
Length	28
Glass Dia	10
Output (Watts)	3
Colour	Clear
Contacts/ Circuits	Single
Reference	504
Part No	GLB504
Price (ea)	£0.76



Bulb Type	Capless
Fitting	W2.1 x 9.5d
Volts	12
Length	28
Glass Dia	10
Output (Watts)	5
Colour	Clear
Contacts/ Circuits	Single
Reference	501
Part No	GLB501
Price (ea)	£0.55



Bulb Type	Capless
Fitting	W2.1 x 9.5d
Volts	12
Length	28
Glass Dia	10
Output (Watts)	5
Colour	Silver/Amber
Contacts/ Circuits	Single
Reference	501
Part No	GLB501S
Price (pair)	£6.95



Bulb Type	Capless
Fitting	W2.1 x 9.5d
Volts	12
Length	28
Glass Dia	10
Output (Watts)	5
Colour	Amber
Contacts/ Circuits	Single
Reference	501
Part No	GLB501X
Price (ea)	£1.15

BPF Fog & Spot Lamp Bulbs



Bulb Type	BPF
Fitting	P36s
Volts	12
Watts	48
Length	64
Glass Dia	28
Cap Dia	36
Colour	Clear
Type	Filament
Contacts /Circuits	Single
Application	Axial filament 576 Driving Lamp
Units	Single
Reference	185
Part No	GLB185
Price (ea)	£4.20



Bulb Type	BPF
Fitting	P36s
Volts	12
Watts	48
Length	64
Glass Dia	28
Cap Dia	36
Colour	Clear
Type	Filament
Contacts /Circuits	Single
Application	Transverse fil. 576 fog lamp
Units	Single
Reference	185
Part No	GLB323
Price (ea)	£4.90

Bulb Kit



This bulb kit includes a range of bulbs for common applications.

Contains one of each of: GLB472, GLB380, GLB382, GLB207, GLB233, GLB239, GLB501, GLB286

Part No	GLB6004	Price (ea)	£6.00
----------------	---------	-------------------	-------



STANDARD BULB



LED BULB (GLB382LW)

LED Bulbs

Bright LEDs are becoming more & more popular and they are an excellent upgrade for your lights. Our LEDs have the advantage of a wide angle light distribution design and can be easily installed with no modifications to your car required. Negative earth only. The LEDs are available in 3 colours (white, red and amber) to match the colour of the lens application. Trust us, you don't want a white light behind a red lens. Pink is not the universal colour for "stop," last we checked. If you are planning to upgrade your indicators to LEDs you will also need to upgrade to an electronic flasher. The LED bulbs draw very little current and this means they won't trigger the mechanical flasher to blink.

Some Classic cars may require a ballast when replacing the indicator bulbs with LEDs as the low amount of current required can lead to the other side LEDs lighting turning the lights into hazards. The ballast simply gives the indicator a ground without leaving extra current for the opposite LED. We supply LED bulb kits which contain a resistor to make the job easier. Please see the LED kits and Ballast Resistor for details on which cars require this. Watch the video on moss-europe.co.uk for more information.



Bulb Type	Bayonet
Fitting	BA15d
Volts	12
Output (Watts)	21/5
Pin Position	Stepped
Colour	Amber
Contacts/ Circuits	Twin
Reference	380
Part No	GLB380LA
Price (ea)	£12.95



Bulb Type	Bayonet
Fitting	BA15d
Volts	12
Output (Watts)	21/5
Pin Position	Stepped
Colour	Red
Contacts/ Circuits	Twin
Reference	380
Part No	GLB380LR
Price (ea)	£12.95



Bulb Type	Bayonet
Fitting	BA15d
Volts	12
Output (Watts)	21/5
Pin Position	Stepped
Colour	White
Contacts/ Circuits	Twin
Reference	380
Part No	GLB380LW
Price (ea)	£12.95



Bulb Type	Bayonet
Fitting	BA15s
Volts	12
Output (Watts)	5
Pin Position	Straight
Colour	Amber
Contacts/ Circuits	Single
Reference	207
Part No	GLB207LA
Price (ea)	£6.95



Bulb Type	Bayonet
Fitting	BA15s
Volts	12
Output (Watts)	5
Pin Position	Straight
Colour	Red
Contacts/ Circuits	Single
Reference	207
Part No	GLB207LR
Price (ea)	£6.95



Bulb Type	Bayonet
Fitting	BA15s
Volts	12
Output (Watts)	5
Pin Position	Straight
Colour	White
Contacts/ Circuits	Single
Reference	207
Part No	GLB207LW
Price (ea)	£6.95



Bulb Type	Bayonet
Fitting	BA15s
Volts	12
Output (Watts)	21
Pin Position	Straight
Colour	Amber
Contacts/ Circuits	Single
Reference	382
Part No	GLB382LA
Price (ea)	£12.95

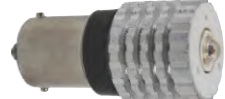

Bulb Type	Bayonet
Fitting	BA15s
Volts	12
Output (Watts)	21
Pin Position	Straight
Colour	Red
Contacts/ Circuits	Single
Reference	382
Part No	GLB382LR
Price (ea)	£12.95



Bulb Type	Bayonet
Fitting	BA15s
Volts	12
Output (Watts)	21
Pin Position	Straight
Colour	White
Contacts/ Circuits	Single
Reference	382
Part No	GLB382LW
Price (ea)	£12.95



Bulb Type	Bayonet
Fitting	BA9s
Volts	12
Output (Watts)	5
Pin Position	Straight
Colour	Amber
Contacts/ Circuits	Single
Reference	233/989
Part No	GLB233LA
Price (ea)	£9.95



Bulb Type	Bayonet
Fitting	BA9s
Volts	12
Output (Watts)	5
Pin Position	Straight
Colour	Red
Contacts/ Circuits	Single
Reference	233/989
Part No	GLB233LR
Price (ea)	£9.95



Bulb Type	Bayonet
Fitting	BA9s
Volts	12
Output (Watts)	5
Pin Position	Straight
Colour	White
Contacts/ Circuits	Single
Reference	233/989
Part No	GLB233LW
Price (ea)	£9.95



Bulb Type	Screw
Fitting	E10
Volts	12
Output (Watts)	2.2
Pin Position	N/A
Colour	White
Contacts/ Circuits	Single
Reference	987
Part No	GLB987LN
Price (ea)	£4.96



Bulb Type	Screw
Fitting	E10
Volts	12
Output (Watts)	2.2
Pin Position	N/A
Colour	White
Contacts/ Circuits	Single
Reference	987
Part No	GLB987LP
Price (ea)	£4.96

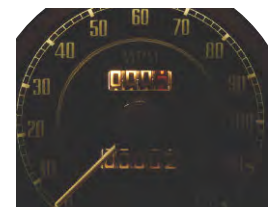

STANDARD BULB



LED BULB (GLB987LN)

Lighting - BULBS

LED Bulb & Ballast Resistor Kits

Some classic car wiring systems require the use of a ballast on the indicators to ensure correct operation. This problem occurs when the dashboard warning lamp is wired between the LH & RH indicator circuits, using the opposing circuit

as an earth. You will require two ballasts per car, one for each side. We offer a bulb & ballast kit which contains 1 bulb & one ballast. Wiring will be required to suit your vehicle.



Bulb Type	Bayonet
Fitting	BA15d
Volts	12
Output (Watts)	21/5
Pin Position	Stepped
Colour	Amber
Contacts/Circuits	Twin
Reference	380
Part No	GLB380LAK
Price (ea)	£16.96



Bulb Type	Bayonet
Fitting	BA15d
Volts	12
Output (Watts)	21/5
Pin Position	Stepped
Colour	Red
Contacts/Circuits	Twin
Reference	380
Part No	GLB380LRK
Price (ea)	£16.96



Bulb Type	Bayonet
Fitting	BA15s
Volts	12
Output (Watts)	21
Pin Position	Straight
Colour	White
Contacts/Circuits	Single
Reference	382
Part No	GLB382LAK
Price (ea)	£16.96



Bulb Type	Bayonet
Fitting	BA15s
Volts	12
Output (Watts)	21
Pin Position	Straight
Colour	Red
Contacts/Circuits	Single
Reference	382
Part No	GLB382LRK
Price (ea)	£16.96



Bulb Type	Ballast resistor
Application	LED bulbs
Part No	170-965
Price (ea)	£4.96





WAXOYL

moss-europe.co.uk

See the Moss Europe Restoration Tools catalogue or visit moss-europe.co.uk

WAXOYL RUST PROTECTION

Probably the most effective aftermarket rust prevention treatment available. Waxoyl is designed for use in cavities such as sills, chassis leg and wheel arches to provide anti-rust protection. It spreads evenly over the applied surface forming an effective seal against the environment.

Underbody seal is a proven product providing protection to the underbody areas of your car such as wheel arches, inner wings, sills and floors. It can be applied to areas at risk of damage from stones, grit, road salt and water to provide a tough flexible barrier, with added Waxoyl for rust inhibiting. Easily applied by brush, aerosol or using the underbody seal gun.



ELITE STOCKIST
moss-europe.co.uk



Autoglym car care products are renowned for being the best, "the choice" of numerous concours competitors and are approved by leading car manufacturers.

Moss Europe Ltd are proud to be appointed an Elite Stockist by Autoglym, for their range of products see the Moss Europe Restoration Tools catalogue or visit moss-europe.co.uk

Battery & Fittings - BATTERIES



Description	Heavy Duty
Voltage	6V
Case Type	Standard
Wet/Dry	Dry*
Cold Cranking SAE	295 Amps
Amp Hours (Ah)	63
Terminal Type	Round Post
Case Size (LxWxH)	170 x 175 x 200mm
Total Height	225mm
Part No.	GBY3031D11
Price (ea)	£77.95



Description	Standard Duty
Voltage	6V
Case Type	Standard
Wet/Dry	Dry*
Cold Cranking SAE	250 Amps
Amp Hours (Ah)	57
Terminal Type	Round Post
Case Size (LxWxH)	170 x 175 x 200mm
Total Height	225mm
Part No.	GBY3031D
Price (ea)	£69.95



Description	Heavy Duty
Voltage	6V
Case Type	Standard
Wet/Dry	Wet*
Cold Cranking SAE	295 Amps
Amp Hours (Ah)	63
Terminal Type	Round Post
Case Size (LxWxH)	170 x 175 x 200mm
Total Height	225mm
Part No.	GBY3031W11
Price (ea)	£77.95



Description	Standard Duty
Voltage	6V
Case Type	Standard
Wet/Dry	Wet*
Cold Cranking SAE	250 Amps
Amp Hours (Ah)	57
Terminal Type	Round Post
Case Size (LxWxH)	170 x 175 x 200mm
Total Height	225mm
Part No.	GBY3031W
Price (ea)	£69.95



Description	Standard Duty
Voltage	12V
Case Type	Classic
Wet/Dry	Dry*
Cold Cranking SAE	265 Amps
Amp Hours (Ah)	63
Terminal Type	Round Post
Case Size (LxWxH)	248 x 170 x 200mm
Total Height	225mm
Part No.	GBY291D
Price (ea)	£154.96



Description	Standard Duty
Voltage	12V
Case Type	Classic
Wet/Dry	Wet*
Cold Cranking SAE	265 Amps
Amp Hours (Ah)	63
Terminal Type	Round Post
Case Size (LxWxH)	248 x 170 x 200mm
Total Height	225mm
Part No.	GBY291
Price (ea)	£154.96



Description	Standard Duty
Voltage	12V
Case Type	Classic
Wet/Dry	Dry*
Cold Cranking SAE	295 Amps
Amp Hours (Ah)	68
Terminal Type	Round Post
Case Size (LxWxH)	307 x 170 x 200mm
Total Height	225mm
Part No.	GBY241D
Price (ea)	£149.95



Description	Standard Duty
Voltage	12V
Case Type	Classic
Wet/Dry	Wet*
Cold Cranking SAE	295 Amps
Amp Hours (Ah)	68
Terminal Type	Round Post
Case Size (LxWxH)	307 x 170 x 200mm
Total Height	225mm
Part No.	GBY241X
Price (ea)	£149.95



Description	Standard Duty
Voltage	12V
Case Type	Classic
Wet/Dry	Dry*
Cold Cranking SAE	295 Amps
Amp Hours (Ah)	68
Terminal Type	Round Post
Case Size (LxWxH)	307 x 170 x 200mm
Total Height	225mm
Part No.	GBY242D
Price (ea)	£149.95



Description	Standard Duty
Voltage	12V
Case Type	Classic
Wet/Dry	Wet*
Cold Cranking SAE	295 Amps
Amp Hours (Ah)	68
Terminal Type	Round Post
Case Size (LxWxH)	307 x 170 x 200mm
Total Height	225mm
Part No.	GBY242X
Price (ea)	£149.95



Description	Standard Duty
Voltage	12V
Case Type	Classic
Wet/Dry	Dry*
Cold Cranking SAE	250 Amps
Amp Hours (Ah)	30
Terminal Type	Round Post
Case Size (LxWxH)	238 x 135 x 181mm
Total Height	206mm
Part No.	GBY5601D
Price (ea)	£63.95



Description	Standard Duty
Voltage	12V
Case Type	Standard
Wet/Dry	Wet*
Cold Cranking SAE	250 Amps
Amp Hours (Ah)	30
Terminal Type	Round Post
Case Size (LxWxH)	238 x 135 x 181mm
Total Height	206mm
Part No.	GBY5601W
Price (ea)	£63.95

***Important Note - Wet & Dry Batteries**

Our wet batteries can only be purchased and collected in store. However, we can ship dry batteries with an 'acid pack' for customers to arrange their own filling and initial charge - just add MQC1134 to your basket. Shipping restrictions apply to MQC1134 which can only be shipped by road.



Description	Standard Duty
Voltage	12V
Case Type	Standard
Wet/Dry	Dry*
Cold Cranking SAE	450 Amps
Amp Hours (Ah)	60
Terminal Type	Round Post
Case Size (LxWxH)	266 x 175 x 178mm
Total Height	203mm
Part No.	GBY5656D
Price (ea)	£96.95



Description	Standard Duty
Voltage	12V
Case Type	Standard
Wet/Dry	Wet*
Cold Cranking SAE	450 Amps
Amp Hours (Ah)	60
Terminal Type	Round Post
Case Size (LxWxH)	266 x 175 x 178mm
Total Height	203mm
Part No.	GBY5656W
Price (ea)	£96.95



Description	Standard Duty
Voltage	12V
Case Type	Standard
Wet/Dry	Dry*
Cold Cranking SAE	450 Amps
Amp Hours (Ah)	60
Terminal Type	Round Post
Case Size (LxWxH)	230 x 170 x 200mm
Total Height	225mm
Part No.	GBY014D
Price (ea)	£89.95



Description	Standard Duty
Voltage	12V
Case Type	Standard
Wet/Dry	Wet*
Cold Cranking SAE	450 Amps
Amp Hours (Ah)	60
Terminal Type	Round Post
Case Size (LxWxH)	230 x 170 x 200mm
Total Height	225mm
Part No.	GBY014W
Price (ea)	£89.95



Description	Standard Duty
Voltage	12V
Case Type	Standard
Wet/Dry	Wet*
Cold Cranking SAE	300 Amps
Amp Hours (Ah)	36
Terminal Type	Round Post
Case Size (LxWxH)	238 x 135 x 181mm
Total Height	206mm
Part No.	GBY015
Price (ea)	£63.95



Description	Standard Duty
Voltage	12V
Case Type	Standard
Wet/Dry	Wet*
Cold Cranking SAE	540 Amps
Amp Hours (Ah)	60
Terminal Type	Round Post
Case Size (LxWxH)	242 x 175 x 165mm
Total Height	190mm
Part No.	GBY076
Price (ea)	£78.95



Description	Standard Duty
Voltage	12V
Case Type	Standard
Wet/Dry	Wet*
Cold Cranking SAE	550 Amps
Amp Hours (Ah)	70
Terminal Type	Round Post
Case Size (LxWxH)	257 x 172 x 178mm
Total Height	203mm
Part No.	GBYL17
Price (ea)	£109.94



Description	Battery Acid Pack
Contents	Contains 6 Bottles, Use 1 Per Cell
Part No.	MQC1134
Price (ea)	£27.95

Battery & Fittings - BATTERY BOXES & TRAYS



Description	Battery Box
Material	ABS plastic
External (LxWxH)	275 x 235 x 250mm
Internal (LxWxH)	185 x 160 x 235mm
Part No	GAC4096X
Price (ea)	£36.95



Description	Battery Box
Material	ABS plastic
External (LxWxH)	TBA
Internal (LxWxH)	TBA
Part No	GAC4097X
Price (ea)	£46.96

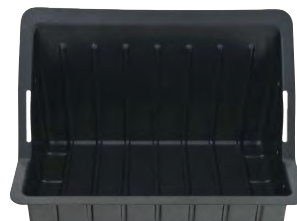

Description	Battery Liner
Material	ABS plastic
External (LxWxH)	385 x 210 x 230mm
Internal (LxWxH)	330 x 180 x 255mm
Part No	AM7300
Price (ea)	£35.95



Description	Battery Liner
Material	ABS plastic
External (LxWxH)	325 x 180 x 225mm
Internal (LxWxH)	300 x 170 x 215mm
Part No	AM7301
Price (ea)	£35.95



Description	Battery Liner
Material	ABS plastic
External (LxWxH)	300 x 210 x 235mm
Internal (LxWxH)	260 x 175 x 230mm
Part No	AM7302
Price (ea)	£30.90



Description	Battery Tray
Material	ABS plastic
External (LxWxH)	275 x 155 x 7mm
Internal (LxWxH)	260 x 140 x 5mm
Part No	ACA9673
Price (ea)	£11.50

Battery & Fittings - BATTERY CLAMP KITS



Description	Twin 6 Volt
Clamp Material	Steel
Clamp Finish	Powder Coated
J Bolt Finish	Plated
J Bolt Length	178mm
J Bolt Thread	1/4" UNF
Clamp Profile	Right Angled
Clamp Length	200mm
Clamp Hole Centres	180mm
Part No	AHH6353K
Price (ea)	£6.65



Description	Twin 6 Volt
Clamp Material	Stainless Steel
Clamp Finish	Polished
J Bolt Finish	Plated
J Bolt Length	178mm
J Bolt Thread	1/4" UNF
Clamp Profile	Right Angled
Clamp Length	200mm
Clamp Hole Centres	180mm
Part No	AHH6353SSK
Price (ea)	£9.46



Description	Single 12 Volt
Clamp Material	Steel
Clamp Finish	Powder Coated
J Bolt Finish	Plated
J Bolt Length	95mm
J Bolt Thread	1/4" UNF
Clamp Profile	Stepped
Clamp Length	290mm
Clamp Hole Centres	225/270mm
Part No	BCK104
Price (ea)	£8.95



Description	Single 12 Volt
Clamp Material	Stainless Steel
Clamp Finish	Polished
J Bolt Finish	Plated
J Bolt Length	95mm
J Bolt Thread	1/4" UNF
Clamp Profile	Stepped
Clamp Length	290mm
Clamp Hole Centres	225/270mm
Part No	BCK104SS
Price (ea)	£12.95



Description	Single 12 Volt
Clamp Material	Steel
Clamp Finish	Powder Coated
J Bolt Finish	Plated
J Bolt Length	205mm
J Bolt Thread	1/4" UNF
Clamp Profile	Right Angled
Clamp Length	360mm
Clamp Hole Centres	340mm
Part No	601898K
Price (ea)	£15.46



Description	Single 12 Volt
Clamp Material	Steel
Clamp Finish	Powder Coated
J Bolt Finish	Plated
J Bolt Length	178mm
J Bolt Thread	1/4" UNF
Clamp Profile	Right Angled
Clamp Length	360mm
Clamp Hole Centres	340mm
Part No	601898K2
Price (ea)	£13.80



Description	Single 12 Volt
Clamp Material	Steel
Clamp Finish	Powder Coated
J Bolt Finish	Plated
J Bolt Length	150mm
J Bolt Thread	1/4" UNF
Clamp Profile	Right Angled
Clamp Length	360mm
Clamp Hole Centres	340mm
Part No	601898K3
Price (ea)	£10.15

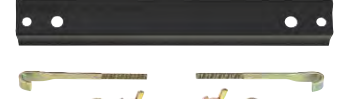

Description	Single 12 Volt
Clamp Material	Steel
Clamp Finish	Powder Coated
J Bolt Finish	Plated
J Bolt Length	100mm
J Bolt Thread	1/4" UNF
Clamp Profile	Stepped
Clamp Length	265mm
Clamp Hole Centres	195mm
Part No	142087K
Price (ea)	£13.10



Description	Single 12 Volt
Clamp Material	Steel
Clamp Finish	Powder Coated
J Bolt Finish	Plated
J Bolt Length	150mm
J Bolt Thread	1/4" UNF
Clamp Profile	Right Angled
Clamp Length	360mm
Clamp Hole Centres	340mm
Part No	ACH5228K
Price (ea)	£10.66

Battery & Fittings - BATTERY CLAMPS



Description	Battery Clamp
Profile	Right Angled
Material	Steel
Finish	Powder Coated
Clamp Length	200mm
Clamp Hole Centres	180mm
Part No	AHH6353
Price (ea)	£1.36



Description	Battery Clamp
Profile	Right Angled
Material	Stainless Steel
Finish	Polished
Clamp Length	200mm
Clamp Hole Centres	180mm
Part No	AHH6353SS
Price (ea)	£5.75



Description	Battery Clamp
Profile	Stepped
Material	Steel
Finish	Powder Coated
Clamp Length	290mm
Clamp Hole Centres	225/270mm
Part No	34G2065
Price (ea)	£3.76



Description	Battery Clamp
Profile	Stepped
Material	Stainless Steel
Finish	Polished
Clamp Length	290mm
Clamp Hole Centres	265mm
Part No	34G2065SS
Price (ea)	£10.66



Description	Battery Clamp
Profile	Right Angled
Material	Steel
Finish	Powder Coated
Clamp Length	360mm
Clamp Hole Centres	340mm
Part No	14G5508
Price (ea)	£3.95



Description	Battery Clamp
Profile	Right Angled
Material	Steel
Finish	Powder Coated
Clamp Length	360mm
Clamp Hole Centres	340mm
Part No	601898
Price (ea)	£7.70



Description	Battery Clamp
Profile	Stepped
Material	Steel
Finish	Powder Coated
Clamp Length	325mm
Clamp Hole Centres	305mm
Part No	157910
Price (ea)	£7.96



Description	Battery Clamp
Profile	Stepped
Material	Steel
Finish	Powder Coated
Clamp Length	355mm
Clamp Hole Centres	280mm
Part No	157740
Price (ea)	£6.95



Description	Battery Clamp
Profile	Stepped
Material	Steel
Finish	Powder Coated
Clamp Length	265mm
Clamp Hole Centres	195mm
Part No	142087
Price (ea)	£4.66



Description	Battery Clamp
Profile	Stepped
Material	Steel
Finish	Powder Coated
Clamp Length	315mm
Clamp Hole Centres	245/395mm
Part No	HAM2457
Price (ea)	£9.95

Battery & Fittings - BATTERY J BOLTS



Description	J Bolt
Finish	Plated
Length	118mm
Thread	1/4" UNF
Part No	AHA7769
Price (ea)	£1.80



Description	J Bolt
Finish	Plated
Length	95mm
Thread	1/4" UNF
Part No	AHA8674
Price (ea)	£1.66

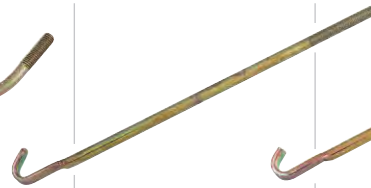

Description	J Bolt
Finish	Plated
Length	203mm
Thread	1/4" UNF
Part No	610798
Price (ea)	£3.95



Description	J Bolt
Finish	Plated
Length	178mm
Thread	1/4" UNF
Part No	618434
Price (ea)	£3.35



Description	J Bolt
Finish	Plated
Length	127mm
Thread	1/4" UNF
Part No	613051
Price (ea)	£1.75



Description	J Bolt
Finish	Plated
Length	105mm
Thread	1/4" UNF
Part No	601552
Price (ea)	£2.56

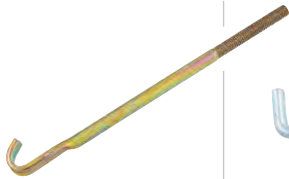

Description	J Bolt
Finish	Plated
Length	150mm
Thread	1/4" UNF
Part No	613051
Price (ea)	£1.75



Description	J Bolt
Finish	Plated
Length	54mm
Thread	1/4" UNF
Part No	5L1159
Price (ea)	£1.60



Description	J Bolt
Finish	Plated
Length	75mm
Thread	1/4" UNF
Part No	YJJ100040
Price (ea)	£1.60



Description	Eye Bolt
Finish	Plated
Length	54mm
Thread	1/4" UNF
Part No	5L1158
Price (ea)	£1.60



Description	Eye Bolt
Finish	Plated
Length	75mm
Thread	1/4" UNF
Part No	YJH100010
Price (ea)	£1.60



Description	Washer
Finish	Plated
Size	1/4" ID x 3/4" OD
Part No	WM57
Price (ea)	£0.25



Description	Wing Nut
Finish	Plated
Thread	1/4" UNF
Part No	132068
Price (ea)	£0.70

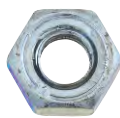

Description	Nut, Plain
Finish	Plated
Thread	1/4" UNF
Part No	GHF200
Price (ea)	£0.10



Battery & Fittings - BATTERY ISOLATOR & CUT-OFF SWITCHES

Fitting a battery cut-off switch enables you to quickly isolate the battery and immobilise the car: essential for motor racing, but also ideal when working on the car, or if you intend to put the car into storage.



Description	Battery Isolator
Type	Standard
Fitting Position	Battery Post (Negative)
Part No	GAC3192X
Price (ea)	£5.95

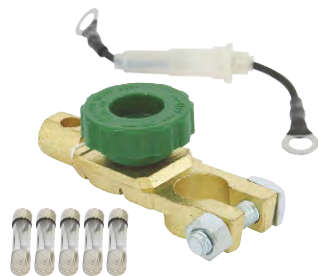

Description	Battery Isolator with Inline Fuse
Type	
Fitting Position	Battery Post (Negative)
Part No	GAC31921
Price (ea)	£8.95



Description	Battery Cut Off
Type	Period Style, Short Knob
Fitting Position	Main Battery Cable
Part No	1B2804
Price (ea)	£27.95



Description	Battery Cut Off
Type	Period Style, Long Knob
Fitting Position	Main Battery Cable
Part No	1B2804L
Price (ea)	£27.95



Description	Battery Cut Off
Type	Competition, FIA
Fitting Position	Main Battery Cable
Part No	TT7962
Price (ea)	£28.10



Description	Battery Cut Off
Type	Standard
Fitting Position	Main Battery Cable
Part No	TT7964
Price (ea)	£16.15



Description	Spare Key
Application	TT7962/TT7964
Part No	TT79641
Price (ea)	£4.36



Description	Terminal Kit
Application	TT7962/TT7964
Part No	TT7964TK
Price (ea)	£8.95

Battery & Fittings - BATTERY CABLES & FITTINGS



Description	Terminal Cap
Material	Rubber
Part No	8G548
Price (ea)	£1.06



Description	Battery Cable
Size	37/0.9mm
Insulation	PVC
Colour	Black
Part No	CQB301M
Price (per metre)	£6.25



Description	Battery Cable
Size	37/0.9mm
Insulation	PVC
Colour	Red
Part No	CQB304M
Price (per metre)	£6.25



Description	Cable Eyelet
Hole Size	10mm
Part No	LUCWB600
Price (ea)	£5.10



Description	Terminal Clamp
Terminal	Negative
Post Type	Round
Part No	GHF2750
Price (ea)	£3.95



Description	Terminal Clamp
Terminal	Positive
Post Type	Round
Part No	GHF2755
Price (ea)	£3.95



Description	Acid Absorbent Mat
Length	300mm
Width	200mm
Part No	GAC2029X
Price (ea)	£6.35



1B2804L

Charging Systems - DYNAMO C40

Dynamo C40 Charging System

New Dynamo C40 for those who prefer to still use a dynamo. This does not include the fan or pulley. The reduction gear is used on the back of the dynamo to reduce the speed of the output for the tacho.



Description	Reduction Gear
Part No	13H632
Price (ea)	£90.40



Description	Dynamo C40
Tacho Drive	N/A
Voltage	12V
Part No	GEU3101
Price (ea)	£59.95



Description	Dynamo
Tacho Drive	Mechanical
Voltage	12V
Part No	AEJ49
Price (ea)	£104.95

Charging Systems - DYNALITE

Dynalite Charging System

If fitting an alternator but prefer to keep the original appearance, then Dynalite is the answer. Basically, it's an alternator in a dynamo C40 casing. All cars must be converted to negative earth for fitting.



Description	Dynalite
Tacho Drive	Electronic
Earth	Negative
Voltage	12V
Drive Belt Width	10mm
Part No	PT10802
Price (ea)	£379.96



Description	Dynalite
Tacho Drive	Electronic
Earth	Positive
Voltage	12V
Drive Belt Width	10mm
Part No	PT10802P
Price (ea)	£502.96

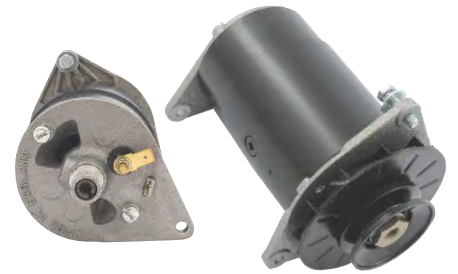

Description	Dynalite
Tacho Drive	Mechanical
Earth	Negative
Voltage	12V
Drive Belt Width	10mm
Part No	PT10802T
Price (ea)	£499.96



Description	Dynalite
Tacho Drive	Mechanical
Earth	Positive
Voltage	12V
Drive Belt Width	10mm
Part No	PT10802TP
Price (ea)	£629.95



Description	Dynalite, Wide Fan Belt
Tacho Drive	Electronic
Earth	Negative
Voltage	12V
Drive Belt Width	19.5mm
Part No	PT10802TR
Price (ea)	£474.95



Description	Dynalite, Wide Fan Belt
Tacho Drive	Electronic
Earth	Positive
Voltage	12V
Drive Belt Width	19.5mm
Part No	PT10802TRP
Price (ea)	£594.95

Charging Systems - ALTERNATORS

Alternators & Fitting

Brand new alternators. For cars wired for 5 electrical terminals, use the 3 wire type plug to convert to the '3 terminal' type alternators.



Description	Plug, 3 Wire Type
Part No	GEU250
Price (ea)	£4.25



Description	18ACR
Amp	45 AMP
Voltage	12V
Part No	GEU2206
Price (ea)	£59.95



Description	17ACR
Amp	34 AMP
Voltage	12V
Part No	GXE8211
Price (ea)	£54.95

Gauges & Instruments - GAUGES

Custom build your own dash assembly with these gauges or add them as auxiliary instruments. Available in either black face with white lettering or a magnolia face with black lettering. All gauges are supplied with a bulb holder and retaining bracket. Sender units and pipes supplied separately.

Tachometers - 80mm diameter



Description	Tacho
Scale (RPM)	0-10,000
Operation	Electronic
Diameter	80mm
Face Type	Full Face
Face Finish	Black
Bezel Shape	Bevel
Bezel Finish	Chrome
Gauge Detail	Smiths
Part No	GAE130A
Price (ea)	£145.96



Description	Tacho
Scale (RPM)	0-8,000
Operation	Electronic
Diameter	80mm
Face Type	Full Face
Face Finish	Magnolia
Bezel Shape	Bevel
Bezel Finish	Chrome
Gauge Detail	Smiths
Part No	GAE130M
Price (ea)	£145.96



Description	Tacho
Scale (RPM)	0-7,000
Operation	Electronic
Diameter	80mm
Face Type	Full Face
Face Finish	Black
Bezel Shape	Bevel
Bezel Finish	Chrome
Gauge Detail	Smiths
Part No	GAE125X
Price (ea)	£127.96

Ammeters



Description	Ammeter
Scale	30-0-30
Generator Type	Dynamo
Diameter	52mm
Face Type	Half Face
Face Finish	Black
Bezel Shape	Bevel
Bezel Finish	Chrome
Gauge Detail	Smiths
Part No	GAE120
Price (ea)	£45.95



Description	Ammeter
Scale	60-0-60
Generator Type	Alternator
Diameter	52mm
Face Type	Half Face
Face Finish	Black
Bezel Shape	Bevel
Bezel Finish	Chrome
Gauge Detail	Smiths
Part No	GAE121
Price (ea)	£45.95

Volt Meters



Description	Volt Meter
Scale	11-15V
Generator Type	Alternator
Diameter	52mm
Face Type	Half Face
Face Finish	Black
Bezel Shape	Bevel
Bezel Finish	Chrome
Gauge Detail	Smiths
Part No	GAE122
Price (ea)	£46.96



Description	Volt Meter
Scale	11-15V
Generator Type	Alternator
Diameter	52mm
Face Type	Half Face
Face Finish	Magnolia
Bezel Shape	Bevel
Bezel Finish	Chrome
Gauge Detail	Smiths
Part No	GAE122M
Price (ea)	£45.95

Time Clocks



Description	Clock
Operation	Electrical
Diameter	52mm
Face Type	Full Face
Face Finish	Black
Bezel Shape	Bevel
Bezel Finish	Chrome
Gauge Detail	Smiths
Part No	GAE128X
Price (ea)	£83.95



Description	Clock
Operation	Electrical
Diameter	52mm
Face Type	Full Face
Face Finish	Magnolia
Bezel Shape	Bevel
Bezel Finish	Chrome
Gauge Detail	Smiths
Part No	GAE128M
Price (ea)	£76.96

Boost Gauges



Description	Boost, Gauge
Scale	-15hg to +30 PSI
Operation	Mechanical
Diameter	52mm
Face Type	Full Face
Face Finish	Magnolia
Bezel Shape	Bevel
Bezel Finish	Chrome
Gauge Detail	Smiths
Part No	GAE150M
Price (ea)	£89.95



Description	Boost, Gauge
Scale	-15hg to +30 PSI
Operation	Mechanical
Diameter	52mm
Face Type	Full Face
Face Finish	Black
Bezel Shape	Bevel
Bezel Finish	Chrome
Gauge Detail	Smiths
Part No	GAE150X
Price (ea)	£89.95



Water Temperature Gauges



Description	Water Temperature
Scale	Centigrade
Operation	Electrical
Diameter	52mm
Face Type	Half Face
Face Finish	Black
Bezel Shape	Bevel
Bezel Finish	Chrome
Gauge Detail	Smiths
Sender Unit Req'd	GAE129SENDER
Part No	GAE124X
Price (ea)	£47.95



Description	Water Temperature
Scale	Centigrade
Operation	Electrical
Diameter	52mm
Face Type	Half Face
Face Finish	Magnolia
Bezel Shape	Bevel
Bezel Finish	Chrome
Gauge Detail	Smiths
Sender Unit Req'd	GAE129SENDER
Part No	GAE124M
Price (ea)	£47.95



Description	Water Temperature
Scale	Centigrade
Operation	Capillary
Diameter	52mm
Face Type	Full Face
Face Finish	Black
Bezel Shape	Bevel
Bezel Finish	Chrome
Gauge Detail	Lucas
Sender Unit Req'd	GAE129SENDER
Part No	LUSIB422
Price (ea)	£90.95

Dual Gauges

Dual gauges are full face with oil pressure and water temperature shown. These gauges include a capillary pipe for water temperature and nylon hose for oil pressure, sold separately.



Description	Water Temp/ Oil Pressure
Scale	°C-N-H/PSI
Operation	Capillary/Mechanical
Diameter	52mm
Face Type	Full Face
Face Finish	Black
Bezel Shape	Bevel
Bezel Finish	Chrome
Gauge Detail	Smiths
Part No	BHA4900
Price (ea)	£108.95



Description	Water Temp/ Oil Pressure
Scale	°F/PSI
Operation	Capillary/Mechanical
Diameter	52mm
Face Type	Full Face
Face Finish	Black
Bezel Shape	Bevel
Bezel Finish	Chrome
Gauge Detail	Smiths
Part No	GAE127X
Price (ea)	£132.95



Description	Water Temp/ Oil Pressure
Scale	°C/PSI
Operation	Capillary/Mechanical
Diameter	52mm
Face Type	Full Face
Face Finish	Black
Bezel Shape	Bevel
Bezel Finish	Chrome
Gauge Detail	Smiths
Part No	LUSJB100
Price (ea)	£86.95

Oil Pressure Gauges



Description	Oil Pressure
Scale	PSI
Operation	Mechanical
Diameter	52mm
Face Type	Half Face
Face Finish	Black
Bezel Shape	Bevel
Bezel Finish	Chrome
Gauge Detail	Smiths
Part No	GAE123X
Price (ea)	£77.95



Description	Oil Pressure
Scale	PSI
Operation	Mechanical
Diameter	52mm
Face Type	Half Face
Face Finish	Magnolia
Bezel Shape	Bevel
Bezel Finish	Chrome
Gauge Detail	Smiths
Part No	GAE123M
Price (ea)	£79.96



Description	Oil Temperature
Scale	Centigrade
Operation	Electrical
Diameter	52mm
Face Type	Half Face
Face Finish	Black
Bezel Shape	Bevel
Bezel Finish	Chrome
Gauge Detail	Smiths
Sender Unit Req'd	GAE129SENDER
Part No	GAE129X
Price (ea)	£53.95



Description	Oil Temperature
Scale	Centigrade
Operation	Electrical
Diameter	52mm
Face Type	Half Face
Face Finish	Magnolia
Bezel Shape	Bevel
Bezel Finish	Chrome
Gauge Detail	Smiths
Sender Unit Req'd	GAE129SENDER
Part No	GAE129M
Price (ea)	£59.95

Gauges & Instruments - GAUGES

Gauge Mounting Plinths

A neat way to fit gauges into your car, available with either a single or dual gauge fitting. The gauge plinths are pressed steel with a crackle finish paint.



Description	Tacho & Gauge Plinth
Gauge Qty	2
Mounting Hole Dia	80mm/52mm
Material	Steel
Colour	Black
Finish	Crinkle
Part No	GAC8461X
Price (ea)	£9.65



Description	Tacho & Gauge Plinth
Gauge Qty	1
Mounting Hole Dia	80mm
Material	Steel
Colour	Black
Finish	Crinkle
Part No	GAC8460X
Price (ea)	£7.66



Description	Tacho & Gauge Plinth
Gauge Qty	1
Mounting Hole Dia	52mm
Material	Steel
Colour	Black
Finish	Crinkle
Part No	GAC8468X
Price (ea)	£8.30

Gauge Fittings



Description	Temperature Sender
Application	Oil/Water Temp Gauges
Operation	Electrical
Thread	3/8 BSP
Part No	GAE129SENDER
Price (ea)	£18.30



Description	Oil Pressure Hose
Material	Nylon
Thread	1/8 NPTF
Length	75"
Part No	LUSIB703
Price (ea)	£12.70



Description	Oil Pressure Hose
Material	Braided
Thread	1/8 NPTF
Length	48"
Part No	MT9102
Price (ea)	£24.95



Description	Y Piece Adaptor
Material	Brass
Thread	1/8 NPTF
Length	37mm
Part No	LUSIB748
Price (ea)	£3.95



Description	Washer
Application	Oil Gauge Pipes
Material	Leather
Part No	2K4936
Price (ea)	£0.20



Description	Oil Pressure Switch
Application	Standard
Thread	1/8 NPTF
Part No	GPS133
Price (ea)	£5.15



Description	Oil Pressure Switch
Application	Up-rated (20psi)
Thread	1/8 NPTF
Part No	TT2998
Price (ea)	£25.96



Accessories - CIGAR LIGHTER

Cigar Lighter - 12 Volt

Retrofit or replace the existing cigar lighter with this illuminated pop out unit. It is also suitable for use as a 12 volt power socket for in-car accessories such as sat-nav or MP3 players. It can be mounted under the dash using the bracket supplied separately.

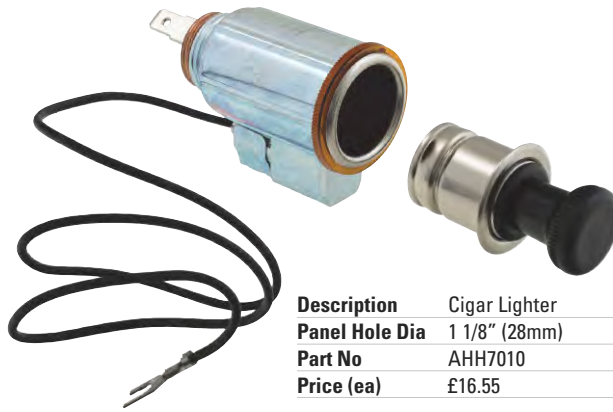

Description	Cigar Lighter
Panel Hole Dia	1 1/8" (28mm)
Part No	AHH7010
Price (ea)	£16.55



Description	Bracket
Part No	AHH7010BKT
Price (ea)	£3.20

Electrical & Ignition - REV LIMITERS

Rev Limiters

The road use rev limiter comes preset to 6000rpm at which point power is gradually reduced. This unit can be preset to your specification. The competition unit is fully adjustable and works by progressively miss-timing the spark.



Description	Rev Limiter, Preset
Type	Road
Cylinders	4 Cylinder
Voltage	12V
Part No	TT2987
Price (ea)	£89.95



Description	Rev Limiter, Adjustable
Type	Competition
Cylinders	4, 6 or 8 Cylinder
Voltage	12V
Part No	RL5
Price (ea)	£134.95

Fuse Boxes & Fuses - FUSE BOXES & HOLDER



Description	Fuse Box
Lucas Type	SF6
Fuse Qty	2
Height	51mm
Width	60mm
Depth	35mm
Part No	1G2613
Price (ea)	£14.95



Description	Fuse Box
Lucas Type	7FJ
Linked Terminals	N/A
Fuse Qty	4
Height	85mm
Width	62mm
Depth	40mm
Part No	37H4727
Price (ea)	£9.95



Description	Fuse Box
Lucas Type	7FJ
Linked Terminals	1 & 3
Fuse Qty	4
Height	85mm
Width	62mm
Depth	40mm
Part No	RTC440A
Price (ea)	£14.95



Description	Fuse Box
Lucas Type	4FJ
Fuse Qty	2
Height	68mm
Width	47mm
Depth	33mm
Part No	606253A
Price (ea)	£9.95



Description	Fuse Holder
Lucas Type	Inline
Fuse Qty	1
Part No	UKC4446
Price (ea)	£1.75



Fuse Packs

Standard glass fuses in packs of 5.

Rating (Amps)	Qty	Part No	Price (pk)
5	5	GFS3005	£1.85
10	5	GFS3010	£1.85
15	5	GFS3015	£1.50
20	5	GFS3020	£1.40
25	5	GFS3025	£1.85
35	5	GFS3035	£1.85
50	5	GFS3050	£1.50

Electrical & Ignition - IGNITION SYSTEM

Coils & Brackets



Description	Coil, Q12
Style	Standard
Type	Non-Ballast
Resistance	1.5Ω
Volts	12V
Bracket	Included
HT Lead Fitting	Screw In
Part No	143-210
Price (ea)	£39.95



Description	Coil
Style	Standard
Type	Non-Ballast
Resistance	1.5Ω
Volts	12V
Bracket	Included
HT Lead Fitting	Screw In
Part No	GCL101
Price (ea)	£16.96



Description	Coil
Style	Standard
Type	Non-Ballast
Resistance	1.5Ω
Volts	12V
Bracket	Included
HT Lead Fitting	Push On
Part No	GCL110
Price (ea)	£11.95



Description	Coil
Style	Standard
Type	Ballast
Resistance	3.0Ω
Volts	12V
Bracket	Included
HT Lead Fitting	Push On
Part No	GCL132
Price (ea)	£12.95



Description	Coil
Style	Sports
Type	Non-Ballast
Output	40,000 Volts
Resistance	1.5Ω
Volts	12V
Bracket	Included
HT Lead Fitting	Push On
Part No	TT2981
Price (ea)	£22.94



Description	Coil
Style	Sports
Type	Ballast
Output	40,000 Volts
Resistance	3.0Ω
Volts	12V
Bracket	Included
HT Lead Fitting	Push On
Part No	TT29812
Price (ea)	£27.95



Description	Bracket/Sleeve Cover
Fitment	Standard
Material	Stainless Steel
Part No	GAC8470CC
Price (ea)	£11.20



Description	Bracket
Fitment	Standard
Material	Stainless Steel
Part No	GAC8470X
Price (ea)	£7.25



Description	Waterproof Cover
Fitment	4 Cylinder Distributors
Material	Plastic
Part No	8G726
Price (ea)	£15.60



Description	Waterproof Cover
Fitment	All Coils
Material	Plastic
Part No	8G727
Price (ea)	£5.03



Description	Pertronix Coil
Volts	12V
HT Lead Fitting	Push On
Type	Non-ballast
Bracket	Use 143-255
Part No	143-265
Price (ea)	£42.95



Description	Pertronix Coil
Volts	12V
HT Lead Fitting	Push On
Type	Ballast
Bracket	Use 143-255
Part No	143-270
Price (ea)	£42.95



Description	HT Lead
Core	Copper
Insulation	PVC
Colour	Black
Length	Per Metre
Part No	AAA5981M
Price (ea)	£2.76



Description	HT Lead
Core	Copper
Insulation	PVC
Colour	Black/Yellow
Length	Per Metre
Part No	TT2982M
Price (ea)	£7.25



Description	Bracket, Pertronix
Fitment	Pertronix Only
Finish	Chrome
Part No	143-255
Price (ea)	£8.95



Pertronix Ignition Coils
 Pertronix Flame Thrower coils are specifically designed to work with their range of electronic contact-less ignition systems. The increased voltage gives a higher spark energy which provides more efficient burn for smoother response and better fuel economy. Available for standard & ballasted ignition systems. See page 95 for Pertronix ignition kits.

Plug Caps

						
Description	Straight	Straight	Angled - 90°	Angled - 90°	Angled - 60°/120°	Angled - 60°/120°
Suppressed	Yes	Yes	Yes	Yes	Yes	Yes
Colour	Red	Black	Red	Black	Red	Black
Seal Colour	Black	Black	Black	Black	Black	Black
Brand	NGK	NGK	NGK	NGK	NGK	NGK
Part No	NSB5	NSB5BLK	NLB5	NLB5BLK	NYB5	NYB5BLK
Price (ea)	£3.16	£3.16	£3.16	£3.16	£3.16	£3.16

		
Description	Angled - 90°	Angled - 90°
Suppressed	Yes	Yes
Colour	Black	Black
Seal Colour	N/A	Black
Brand	'Lucas Type'	Champion
Part No	3H1422	WCX600
Price (ea)	£5.60	£6.85



NGK Plug Caps

Waterproof NGK plug caps are available in a choice of three different angles: Straight, 90° and 60°/120° to suit various applications.

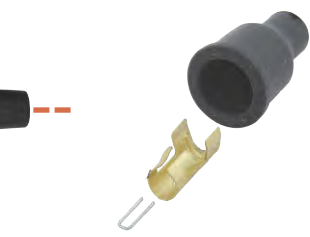

Coil Connector Kit

Only required when making up HT leads.

Description	Coil Lead End Kit
Fitting	Push On
Part No	GCL1110
Price (ea)	£1.25

HT Lead Numbering Set



Description	HT Lead Number Set
Fitment	4 Cylinder
Quantity	4
Colour	Yellow/Black
Material	Plastic
Part No	CRST255
Price (ea)	£3.95



Description	HT Lead Number Set
Fitment	6 Cylinder
Quantity	6
Colour	Yellow/Black
Material	Plastic
Part No	171-640
Price (ea)	£9.70

Waterproof Ignition Covers



Description	Waterproof Cover
Fitment	4 Cylinder Distributors
Material	Plastic
Part No	8G726
Price (ea)	£15.60



Description	Waterproof Cover
Fitment	All Coil
Material	Plastic
Part No	8G727
Price (ea)	£5.03

Distributor Vacuum Pipe & Connectors



Description	Connector - 90°
Material	Rubber
Part No	12B2062
Price (ea)	£0.90



Description	Connector - Straight
Material	Rubber
Part No	12B2095
Price (ea)	£0.95

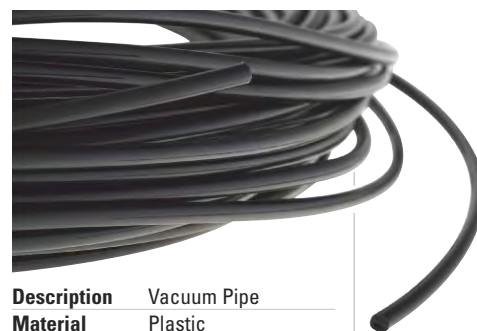

Description	Vacuum Pipe
Material	Plastic
Part No	37H4229M
Price (per metre)	£1.36

Flasher Units, Relays & Solenoids

Flasher Units



Pin Type	3 Pin Lucar
Body Type	Round
Operation	Thermal
Circuit	Indicators
Side Repeater	No
Bulb Type	Filament
Wattage	2 x 21w
Voltage	12V
Part No	GFU2103
Price (ea)	£3.35



Pin Type	3 Pin Screw-On
Body Type	Round
Operation	Thermal
Circuit	Indicators
Side Repeater	No
Bulb Type	Filament
Wattage	2 x 21w
Voltage	12V
Part No	GFU2101
Price (ea)	£6.95



Pin Type	2 Pin Lucar
Body Type	Square
Operation	Thermal
Circuit	Indicators
Side Repeater	Yes
Bulb Type	Filament
Wattage	2 x 21w + 5w
Voltage	12V
Part No	GFU2124
Price (ea)	£3.85



Pin Type	2 Pin Lucar
Body Type	Square
Operation	Thermal
Circuit	Hazards
Side Repeater	Yes
Bulb Type	Filament
Wattage	N/A
Voltage	12V
Part No	GFU204
Price (ea)	£3.95



Pin Type	2 Pin Lucar
Body Type	Round
Operation	Thermal
Circuit	Hazards
Side Repeater	Yes
Bulb Type	Filament
Wattage	N/A
Voltage	12V
Part No	GFU2204
Price (ea)	£3.80



Pin Type	3 Pin Lucar
Body Type	Round
Operation	Thermal
Circuit	Hazards
Side Repeater	Yes
Bulb Type	Filament
Wattage	N/A
Voltage	12V
Part No	GFU2208
Price (ea)	£18.95



Pin Type	2 Pin Lucar
Body Type	Round
Operation	Thermal
Circuit	Hazards
Side Repeater	Yes
Bulb Type	Filament
Wattage	N/A
Voltage	12V
Part No	GFU2218
Price (ea)	£7.96



Pin Type	2 Pin
Body Type	Round
Operation	Electronic
Circuit	Indicators
Side Repeater	Yes
Bulb Type	Filament
Wattage	N/A
Voltage	12V
Part No	GFU2124X
Price (ea)	£6.95



Pin Type	3 Pin
Body Type	Round
Operation	Electronic
Circuit	Indicators
Side Repeater	Yes
Bulb Type	Filament
Wattage	N/A
Voltage	12V
Part No	GFU2103X
Price (ea)	£6.95



Pin Type	2 Pin
Body Type	Round
Operation	Electronic
Circuit	Indicators
Side Repeater	Yes
Bulb Type	LED
Wattage	N/A
Voltage	12V
Part No	GFU2124XL
Price (ea)	£9.95



Pin Type	3 Pin
Body Type	Round
Operation	Electronic
Circuit	Indicators
Side Repeater	Yes
Bulb Type	LED
Wattage	N/A
Voltage	12V
Part No	GFU2103XL
Price (ea)	£9.95

Indicator Relay
Many British cars used flashing front side markers and brake lights as indicators. These systems use this indicator relay and flasher unit (Part No: GFU2103) to operate. Used on Morris Minors and MGAs along with numerous other cars.



Description	Indicator Relay
Type	Lucas 33117
Size	110 x 80 x 50mm
Voltage	12V
Part No	3H1454
Price (ea)	£59.95

Starter Solenoids



Description	Starter Solenoid
Lucas No	SRB335
Type	Ballast Ignition
Shape	Rectangle
Material	Metal/Plastic
Part No	13H5952
Price (ea)	£9.95



Description	Starter Solenoid
Lucas No	SRB316
Type	Non Ballast
Shape	Round
Material	Metal/Plastic
Part No	BCA4501
Price (ea)	£24.95

Relays



Description	Relay
Lucas No	6RA/SRB111
Shape	Rectangle
Material	Metal
Part No	142169A
Price (ea)	£21.50



Description	Relay
Lucas No	26RA/SRB403
Shape	Round
Material	Plastic
Part No	CHM68
Price (ea)	£14.10



Description	Relay
Lucas No	26RA/SRB520
Shape	Square
Material	Plastic
Part No	CHM68SQ
Price (ea)	£4.80



Description	Relay
Lucas No	22RA/SRB301
Shape	Square
Material	Plastic
Part No	C36611
Price (ea)	£59.95



Description	Relay
Lucas No	28RA/SRB500
Shape	Square
Material	Plastic
Part No	YWB10032
Price (ea)	£4.15

Horns



Description	Altette Horn
Tone	Low
Volts	12V
Material	Metal
Finish	Chrome/Black
Quantity	Each
Part No	165-900
Price (ea)	£120.95



Description	Wintone Horn Set
Tone	High/Low
Volts	12V
Material	Metal
Finish	Black
Quantity	Pair
Part No	1B9007/8
Price (pair)	£64.96



Description	Wintone Horn
Tone	Low
Volts	12V
Material	Metal
Finish	Black
Quantity	Each
Part No	1B9007
Price (ea)	£31.96

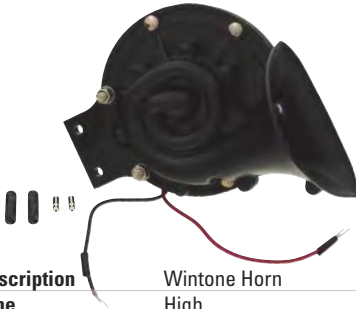

Description	Wintone Horn
Tone	High
Volts	12V
Material	Metal
Finish	Black
Quantity	Each
Part No	1B9008
Price (ea)	£31.96



Description	Horn Set
Tone	High/Low
Volts	12V
Material	Plastic
Finish	Black
Quantity	Pair
Part No	GGE164/5
Price (pair)	£13.20



Description	Horn
Tone	Low
Volts	12V
Material	Plastic
Finish	Black
Quantity	Each
Part No	GGE164
Price (ea)	£13.20



Description	Horn
Tone	High
Volts	12V
Material	Plastic
Finish	Black
Quantity	Each
Part No	GGE165
Price (ea)	£13.20



Description	Horn
Tone	High
Volts	12V
Material	Metal
Finish	Black
Quantity	Each
Part No	BHA4515
Price (ea)	£34.96



Description	Horn
Tone	Low
Volts	12V
Material	Metal
Finish	Black
Quantity	Each
Part No	BHA4514
Price (ea)	£34.96



Description	Air Horn Set
Tone	High/Low
Volts	12V
Material	Metal/Plastic
Finish	Red/Black
Quantity	Pair
Part No	GAC9978X
Price (pair)	£33.95



Description	Classic Horn
Tone	High
Volts	12V
Material	Metal
Finish	Black/Chrome
Quantity	Each
Part No	MT9143
Price (ea)	£15.25

Horn Button

Surface mounted horn button, requires hole for cables.



Application	Horn
Part No	2H3383
Price (ea)	£19.30

Switches & Controls

Headlamp Dip Switch



Description	Dip Switch, Floor Mounted
Material	Metal
H x W x D	67 x 76 x 40mm
Part No	11G2007
Price (ea)	£25.15



Description	Dip Switch, Floor Mounted
Material	Metal
H x W x D	59 x 55 x 46mm
Part No	502087A
Price (ea)	£18.00

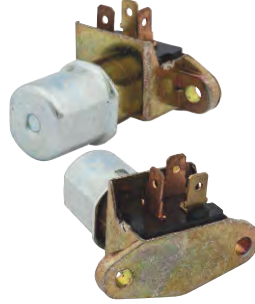

Description	Dip Switch, Floor Mounted
Material	Metal
H x W x D	51 x 51 x 31mm
Part No	RTC432A
Price (ea)	£10.75

Toggle Switches

The traditional toggle switch as used in numerous British classics.



Handle	Hooked
Positions	Off/On
Typical use	Auxiliary Lamps
Bezel	Round Nut
Hole Dia.	1/2" / (13mm)
Rating (Amps)	5A
Part No	BHA4513
Price (ea)	£13.94



Handle	Straight
Positions	Off/On
Typical use	Side Lamps/Wiper
Bezel	Round Nut
Hole Dia.	1/2" / (13mm)
Rating (Amps)	10A
Part No	149011A
Price (ea)	£18.20

Pull Switches

These switches all operate with a Pull-On function.



Positions	Single
Type	Off/On
Uses	Side Lights/Wipers
Bezel	Knurled Nut
Hole Dia.	3/8" (9.5mm)
Shaft	Hex
Rating (Amps)	10A
Part No	2H4841
Price (ea)	£11.95



Positions	Twin
Type	Off/On/On
Uses	Headlamps/Wipers
Bezel	Round Nut
Hole Dia.	9/16" (14mm)
Shaft	Hex
Rating (Amps)	10A
Part No	BHA4578
Price (ea)	£24.95



Positions	Twin
Type	Off/On/Turn-Pull-On
Uses	Headlamps
Bezel	Round Nut
Hole Dia.	7/16" (11mm)
Shaft	Hex
Rating (Amps)	10A
Part No	3H3098
Price (ea)	£21.95

Pull Switches - Auxiliary

Ideal for accessory items where a warning light is required.



Description	Pull Switch
Detail	Illuminated
Type	Off/On
Bezel	Round Nut
Hole Dia.	1/2" / (13mm)
Illumination	White
Colour	White
Rating (Amps)	10A
Part No	GAE132
Price (ea)	£12.25



Description	Pull Switch
Detail	Illuminated
Type	Off/On
Bezel	Round Nut
Hole Dia.	1/2" / (13mm)
Illumination	Green
Colour	Green
Rating (Amps)	10A
Part No	GAE132G
Price (ea)	£12.25

Knobs: Pull Switches (Triumph TR2-3A Style)

These knobs fit the hexagonal shaft of the pull switches.



Application	Lights
Marking	Side - Head
Part No	106685
Price (ea)	£5.86



Application	Dash Lights
Marking	Panel
Part No	107680
Price (ea)	£2.60



Application	Dash Lights
Marking	Panel & Arrow
Part No	125677
Price (ea)	£4.55



Application	Starter
Marking	Starter - Push
Part No	109311
Price (ea)	£4.50



Application	Wipers
Marking	Wiper
Part No	106689
Price (ea)	£5.15



Application	Washers
Marking	Pictorial
Part No	609946
Price (ea)	£4.14



Application	Dash Lights
Marking	Pictorial
Part No	704879
Price (ea)	£6.60



Application	Heater Fan
Marking	Pictorial
Part No	704883
Price (ea)	£6.60



Application	Air Distribution
Marking	Pictorial
Part No	704881
Price (ea)	£6.60



Application	Heat Control
Marking	Pictorial
Part No	704884
Price (ea)	£6.60

We have a range of period looking switches for general purpose use. Use a momentary switch for starters, horns, washers and the on/off switches for auxiliary lamps.



Handle	Straight
Positions	Off/On
Typical use	Side Lamps/ Aux. Lamps
Bezel	Round Nut
Hole Dia.	1/2" / (13mm)
Rating (Amps)	5A
Part No	RTC430A
Price (ea)	£4.96



Handle	Straight
Positions	Off/On
Typical use	Side Lamps/ Aux. Lamps
Bezel	Round Nut
Hole Dia.	1/2" / (13mm)
Rating (Amps)	5A
Part No	RTC430AZ
Price (ea)	£8.95



Handle	Straight
Positions	Off/On/On
Typical use	Headlamps/ Wiper
Bezel	Hex Nut
Hole Dia.	1/2" / (13mm)
Rating (Amps)	10A
Part No	1H9077
Price (ea)	£11.95



Handle	Straight
Positions	Off/On/On
Typical use	Headlamps/ Wiper
Bezel	Round Nut
Hole Dia.	1/2" / (13mm)
Rating (Amps)	10A
Part No	BHA4786
Price (ea)	£19.96



Handle	Jaguar
Positions	Momentary
Typical use	Windscreen Washers
Bezel	Round Nut
Hole Dia.	1/2" / (13mm)
Rating (Amps)	5A
Part No	GWV102X
Price (ea)	£17.20



Description	Pull Switch
Detail	Illuminated
Type	Off/On
Bezel	Round Nut
Hole Dia.	1/2" / (13mm)
Illumination	
Colour	Red
Rating (Amps)	10A
Part No	GAE132R
Price (ea)	£12.25



Description	Pull Switch
Detail	Illuminated
Type	Off/On
Bezel	Round Nut
Hole Dia.	1/2" / (13mm)
Illumination	
Colour	Yellow
Rating (Amps)	10A
Part No	GAE132Y
Price (ea)	£12.25

Push Switches

Momentary operation sprung return push switch.



Positions	Single
Type	Momentary
Uses	Starter, Washer
Bezel	Round Nut
Hole Dia.	9/16" (14mm)
Shaft	Hex
Rating (Amps)	10A
Part No	501777
Price (ea)	£39.95



Positions	Single
Type	Momentary
Uses	Starter, Washer
Bezel	Round Nut
Hole Dia.	11/16" (17.5mm)
Shaft	N/A
Rating (Amps)	5A
Part No	3H3058
Price (ea)	£14.95



Rheostat

Rheostat for panel lights and heater blowers.

Description	Rheostat
Hole Dia.	9/16" (14mm)
Shaft	Hex
Part No	BHA4278
Price (ea)	£55.96

Knobs: Pull Switches (Triumph TR4-4A Style)

These knobs fit the hexagonal shaft of the pull switches and choke & heater cables on pages 8-12.



Application	Choke
Marking	Choke - Pull
Part No	107764
Price (ea)	£5.45



Application	Overdrive
Marking	Overdrive - Pull
Part No	108437
Price (ea)	£1.55



Application	Lights
Marking	Pictorial
Part No	704885
Price (ea)	£6.60



Application	Wipers
Marking	Pictorial
Part No	704875
Price (ea)	£6.60



Application	Choke
Marking	Pictorial
Part No	704873
Price (ea)	£6.60

Knobs: Pull Switches (BMC Style)

These knobs fit the hexagonal shaft of the pull switches and choke & heater cables on pages 8-12.



Application	Wipers
Marking	'W'
Part No	AHH5364
Price (ea)	£3.95



Application	Dash Lights
Marking	'P'
Part No	AHH5368
Price (ea)	£3.95



Application	Fog Lamps
Marking	'F'
Part No	AHH5366
Price (ea)	£3.95



Application	Lights
Marking	'L'
Part No	AHH5360
Price (ea)	£3.95



Application	Universal
Marking	Plain
Part No	AHH5362
Price (ea)	£3.95



Switches & Controls

Knobs: Pull Switches (Triumph TR6 Style)

These knobs fit the hexagonal shaft of the pull switches and choke & heater cables on pages 8-12.



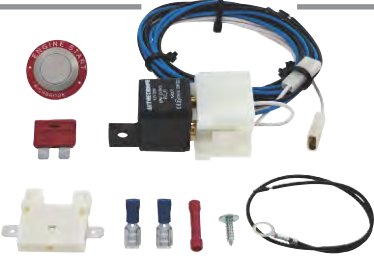
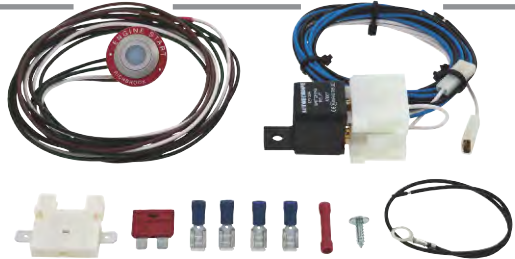

				
Application Choke	Application Choke	Application Dash Lights	Application Heat Control	Application Heat Control
Marking Pictorial	Marking Text	Marking Pictorial	Marking Pictorial	Marking Text
Part No 712907	Part No 725373	Part No 621726	Part No 712903	Part No 725372
Price (ea) £3.85	Price (ea) £3.30	Price (ea) £3.60	Price (ea) £3.85	Price (ea) £3.30





			
Application Air Distribution	Application Air Distribution	Application Heater Fan	Application Heater Fan
Marking Pictorial	Marking Text	Marking Pictorial	Marking Text
Part No 712909	Part No 725370	Part No 712911	Part No 725371
Price (ea) £3.85	Price (ea) £3.30	Price (ea) £3.85	Price (ea) £3.30

			
GAC0060	GAC0061	Description Push Button	Description Push Button with LED
		Hole Dia. 3/4"/19mm	Hole Dia. 3/4"/19mm
		Voltage 12V	Voltage 12V
		Part No GAC0060	Part No GAC0061
		Price (ea) £31.96	Price (ea) £41.95

Ignition - DISTRIBUTOR COMPONENTS

Condensers & LT Connector Block

				
Description Condenser	Description Condenser	Description Condenser	Description Condenser	Description Screw,
Distributor AC Delco	Distributor DM2, DM6, 22D,	Distributor Lucas 45D, 59D	Distributor Lucas 45D	Distributor Condenser
Part No GSC104	Part No 23D, 25D, 35D	Part No GSC2109	Part No GSC2118	Part No GSC1001S
Price (ea) £2.45	Price (ea) £2.45	Price (ea) £2.45	Price (ea) £3.46	Price (ea) £0.46

			
Description LT Block & Lead	Description LT Block & Lead	Description LT Block & Lead	Description LT Block & Lead
Distributor Lucas DM2	Distributor Lucas DM2	Distributor Lucas 25D	Distributor Lucas 25D
Terminal Screw	Terminal Lucar	Terminal Lucar	Terminal Lucar
Direction N/A	Direction Upwards	Direction Upwards	Direction Downwards
Part No 502283	Part No 57H5346	Part No 600329A	Part No 37H2981
Price (ea) £21.95	Price (ea) £13.96	Price (ea) £8.95	Price (ea) £7.96

Pertronix Ignition Kits

PERTRONIX

These completely self-contained electronic ignition units offer a simple alternative to traditional points and condenser arrangement. They are easy to install with no external control boxes to mount and only two wires to hook up and no

permanent modifications involved. The unit uses a sealed Hall Effect sensor that is impervious to dirt, dust, moisture, or vibration, and retains standard advance curve. Unaffected by distributor shaft wear, maintains firing accuracy to within 1/4 degree, reduces spark scatter over the full rpm range. One year warranty.

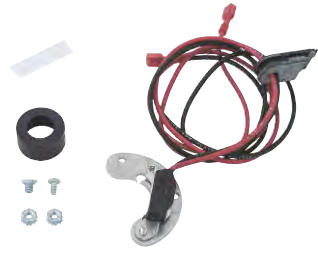

Description	Pertronix Ignition Kit
Distributor	Lucas 22D
Cylinders	6
Earth Type	Negative
Part No	222-395
Price (ea)	£99.95



Description	Pertronix Ignition Kit
Distributor	Lucas 23D, 25D
Cylinders	4
Earth Type	Negative
Part No	222-405
Price (ea)	£99.95



Description	Pertronix Ignition Kit
Distributor	Lucas 23D, 25D
Cylinders	4
Earth Type	Positive
Part No	222-555
Price (ea)	£99.95



Description	Pertronix Ignition Kit
Distributor	Lucas 23D, 25D
Cylinders	6
Earth Type	Positive
Part No	222-560
Price (ea)	£99.95



Description	Pertronix Ignition Kit
Distributor	Lucas 25D
Cylinders	6
Earth Type	Negative
Part No	222-415
Price (ea)	£99.95



Description	Pertronix Ignition Kit
Distributor	Lucas 35D
Cylinders	8
Earth Type	Negative
Part No	222-545
Price (ea)	£99.95



Description	Pertronix Ignition Kit
Distributor	Lucas 45D
Cylinders	4
Earth Type	Negative
Part No	222-435
Price (ea)	£99.95



Description	Pertronix Ignition Kit
Distributor	Lucas 45DE, 47DM
Cylinders	4
Earth Type	Negative
Part No	222-425
Price (ea)	£99.95



Description	Pertronix Ignition Kit
Distributor	AC Delco D204, D200
Cylinders	4
Earth Type	Negative
Part No	222-485
Price (ea)	£114.95



Description	Pertronix Ignition Kit
Distributor	AC Delco D204
Cylinders	6
Earth Type	Negative
Part No	222-486
Price (ea)	£135.95



Description	Pertronix Ignition Kit
Distributor	Lucas DKY4A
Cylinders	4
Earth Type	Negative
Part No	222-573
Price (ea)	£114.95



Description	Pertronix Ignition Kit
Distributor	Lucas DKY4A
Cylinders	4
Earth Type	Positive
Part No	222-563
Price (ea)	£114.95



Description	Pertronix Ignition Kit
Distributor	Lucas DM2
Cylinders	4
Earth Type	Negative
Part No	222-605
Price (ea)	£99.95



Description	Pertronix Ignition Kit
Distributor	Lucas DM2
Cylinders	4
Earth Type	Positive
Part No	222-615
Price (ea)	£99.95



Description	Pertronix Ignition Kit
Distributor	Lucas DMBZ6A, DM6
Cylinders	6
Earth Type	Negative
Part No	222-571
Price (ea)	£114.95



Description	Pertronix Ignition Kit
Distributor	Lucas DMBZ6A, DM6
Cylinders	6
Earth Type	Positive
Part No	222-570
Price (ea)	£114.95

Ignition - DISTRIBUTOR COMPONENTS

Distributor Caps



Description	Distributor Cap
Distributor	Lucas 23D, 25D
Cylinders	4
Entry Point	Side
HT Lead Fixing	Screw
Cap Fixing	Clip
Part No	GDC102
Price (ea)	£9.76



Description	Distributor Cap
Distributor	Lucas 23D, 25D
Cylinders	4
Entry Point	Top
HT Lead Fixing	Push
Cap Fixing	Clip
Part No	GDC103
Price (ea)	£4.20



Description	Distributor Cap
Distributor	Lucas 23D, 25D
Cylinders	4
Entry Point	Top
HT Lead Fixing	Push
Cap Fixing	Clip
Part No	GDC103Z
Price (ea)	£3.50



Description	Distributor Cap
Distributor	Lucas 23D, 25D
Cylinders	4
Entry Point	Side
HT Lead Fixing	Screw
Cap Fixing	Clip
Part No	GDC114
Price (ea)	£10.94



Description	Distributor Cap
Distributor	Lucas 22D, 25D
Cylinders	6
Entry Point	Top
HT Lead Fixing	Nut
Cap Fixing	Clip
Part No	GDC105
Price (ea)	£13.96



Description	Distributor Cap
Distributor	Lucas 22D, 25D
Cylinders	6
Entry Point	Top
HT Lead Fixing	Push
Cap Fixing	Clip
Part No	GDC115
Price (ea)	£9.35



Description	Distributor Cap
Distributor	Lucas 22D, 25D
Cylinders	6
Entry Point	Top
HT Lead Fixing	Push
Cap Fixing	Clip
Part No	GDC115Z
Price (ea)	£5.95



Description	Distributor Cap
Distributor	Lucas 22D, 25D
Cylinders	6
Entry Point	Side
HT Lead Fixing	Screw
Cap Fixing	Clip
Part No	GDC101
Price (ea)	£19.96



Description	Distributor Cap
Distributor	Lucas 35D
Cylinders	8
Entry Point	Top
HT Lead Fixing	Push
Cap Fixing	Clip
Part No	GDC146
Price (ea)	£23.95



Description	Distributor Cap
Distributor	Lucas 45D
Cylinders	4
Entry Point	Side
HT Lead Fixing	Screw
Cap Fixing	Clip
Part No	GDC134
Price (ea)	£29.95



Description	Distributor Cap
Distributor	Lucas 45D
Cylinders	4
Entry Point	Side
HT Lead Fixing	Push
Cap Fixing	Screw
Part No	GDC142
Price (ea)	£12.95



Description	Distributor Cap
Distributor	Lucas 45D
Cylinders	4
Entry Point	Top
HT Lead Fixing	Push
Cap Fixing	Clip
Part No	GDC136
Price (ea)	£5.95



Description	Distributor Cap
Distributor	AC Delco
Cylinders	4
Entry Point	Top
HT Lead Fixing	Push
Cap Fixing	Clip
Part No	GDC110
Price (ea)	£9.95



Description	Distributor Cap
Distributor	AC Delco
Cylinders	4
Entry Point	Top
HT Lead Fixing	Push
Cap Fixing	Clip
Part No	GDC123
Price (ea)	£5.45



Description	Distributor Cap
Distributor	AC Delco
Cylinders	6
Entry Point	Top
HT Lead Fixing	Push
Cap Fixing	Clip
Part No	GDC109
Price (ea)	£8.95



Description	Distributor Cap
Distributor	Lucas DM2
Cylinders	4
Entry Point	Top
HT Lead Fixing	Nut
Cap Fixing	Clip
Part No	GDC107
Price (ea)	£9.95



Description	Distributor Cap
Distributor	Lucas DM6
Cylinders	6
Entry Point	Side
HT Lead Fixing	Screw
Cap Fixing	Clip
Part No	GDC106
Price (ea)	£24.95



NGK Spark Plugs

NGK are excellent quality spark plugs and are used as original equipment to most modern manufacturers.



ID No.	Thread Dia.	Thread Length	Reference	Part No	Price (ea)
1	14mm	19mm	N12Y	BP5ES	£3.55
	14mm	12.7mm	L92Y	BP5HS	£3.55
	14mm	19mm	N9Y	BP6ES	£3.25
	14mm	12.7mm	L87Y	BP6HS	£3.55
2	14mm	19mm		BP7ES	£3.55
	14mm	12.7mm		BP7HS	£3.55
	14mm	19mm		BP8ES	£4.55
3	14mm	19mm		BPR4ES	£3.40
	14mm	19mm		BPR6ES	£4.90

Rotor Arms



Description	Rotor Arm
Distributor	Lucas DM2, DM6, 22D, 23D, 25D
Cylinders	4
Colour	Black
Grade	Standard
Part No	GRA2101
Price (ea)	£1.75



Description	Rotor Arm
Distributor	Lucas DM2, DM6, 22D, 23D, 25D
Cylinders	4
Colour	Red
Grade	High Quality
Part No	GRA2101HQ
Price (ea)	£7.50



Description	Rotor Arm
Distributor	Lucas DM2, DM6, 22D, 23D, 25D
Cylinders	6
Colour	Black
Grade	Standard
Part No	GRA102
Price (ea)	£2.15



Description	Rotor Arm
Distributor	Lucas DM2, DM6, 22D, 23D, 25D
Cylinders	6
Colour	Red
Grade	High Quality
Part No	GRA102HQ
Price (ea)	£7.50



Description	Rotor Arm
Distributor	Lucas 35D
Cylinders	8
Colour	Black
Grade	Standard
Part No	GRA117
Price (ea)	£15.25



Description	Rotor Arm
Distributor	Lucas 45D
Cylinders	4
Colour	Black
Grade	Standard
Part No	GRA2114
Price (ea)	£1.50



Description	Rotor Arm
Distributor	Lucas 45D
Cylinders	4
Colour	Red
Grade	High Quality
Part No	GRA2114HQ
Price (ea)	£6.00



Description	Rotor Arm
Distributor	Lucas 45D
Cylinders	4
Colour	Black
Grade	Standard
Part No	GRA2115
Price (ea)	£16.10



Description	Rotor Arm
Distributor	AC Delco
Cylinders	4
Colour	Black
Grade	Standard
Part No	GRA111
Price (ea)	£6.59



Description	Rotor Arm
Distributor	AC Delco
Cylinders	4/6
Colour	Black
Grade	Standard
Part No	GRA110
Price (ea)	£4.25

Contact Sets 'Points'



Description	Contact Set
Distributor	Lucas 22D, 23D, 25D
Cylinders	4/6
Part No	GCS107
Price (ea)	£3.95



Description	Contact Set
Distributor	Lucas 22D, 23D, 25D
Cylinders	4/6
Part No	GCS2101
Price (ea)	£2.15



Description	Screw, Point
Distributor	Lucas 22D, 23D, 25D
Cylinders	4/6
Part No	GCS1001S
Price (ea)	£0.60



Description	Contact Set
Distributor	Lucas DK4 & DVXH6A
Cylinders	4/6
Part No	GCS112
Price (ea)	£7.66



Description	Contact Set
Distributor	Lucas 35D8
Cylinders	8
Part No	GCS117
Price (ea)	£5.95



Description	Contact Set
Distributor	Lucas 35D8
Cylinders	8
Part No	GCS108
Price (ea)	£6.95



Description	Contact Set
Distributor	Lucas 35D8
Cylinders	8
Part No	GCS114
Price (ea)	£10.94



Description	Contact Set
Distributor	Lucas 45D
Cylinders	4/6
Part No	GCS118
Price (ea)	£2.15



Description	Screw, Point
Distributor	Lucas 45D
Cylinders	4/6
Part No	GCS1002S
Price (ea)	£0.85



Description	Contact Set
Distributor	Lucas 49D
Cylinders	4/6
Part No	GCS124
Price (ea)	£2.50



Description	Contact Set
Distributor	Lucas DM6
Cylinders	6
Part No	GCS2102
Price (ea)	£3.95



Description	Contact Set
Distributor	AC Delco
Cylinders	4/6
Part No	GCS105
Price (ea)	£4.55



Description	Contact Set
Distributor	AC Delco
Cylinders	4/6
Part No	GCS106
Price (ea)	£2.95

Wipers & Washers - WINDSCREEN WASHERS

Having a good washer and wiper set up is a necessity. Washer kits include a bottle, pump and bracket. Alternatively they are available separately.

Windscreen Washer Bottle Kits



Description	Washer Bottle & Pump Kit
Operation	Electric
Bottle Shape	Square
Bottle Material	Plastic
H x W x D	126 x 140 x 110mm
Voltage	12V
Includes	Bottle, Cap/Pump & Bracket
Part No	215822X
Price (ea)	£53.95



Description	Washer Bottle & Pump Kit
Operation	Electric
Bottle Shape	Oval
Bottle Material	Plastic
H x W x D	140 x 130 x 90mm
Voltage	12V
Includes	Bottle, Cap/Pump & Bracket
Part No	TKC909
Price (ea)	£49.95



Description	Washer Kit
Operation	Electric
Bottle Shape	Square
Bottle Material	Plastic
H x W x D	185 x 135 x 70mm
Voltage	12V
Includes	Bottle, Bracket, Pump & Switch
Part No	GAC9213X
Price (ea)	£23.95



Description	Washer Bottle Kit
Operation	Manual
Bottle Shape	Round
Bottle Material	Plastic
H x W x D	160 x 75 x 75mm
Voltage	N/A
Includes	Bottle, Cap & Foot Valve
Part No	GWW918K
Price (ea)	£9.95



Description	Washer Bottle & Pump Kit
Operation	Electric
Bottle Shape	Square
Bottle Material	Glass
H x W x D	215 x 215 x 135mm
Voltage	12V
Includes	Bottle, Cap/Pump & Bracket
Part No	GAC9211X
Price (ea)	£236.95



Description	Washer Bottle & Pump Kit
Operation	Electric
Bottle Shape	Square
Bottle Material	Glass
H x W x D	215 x 215 x 135mm
Voltage	12V
Includes	Bottle, Cap/Pump & Bracket
Part No	GAC9211X
Price (ea)	£236.95

Washer Tubing & Fittings



Description	Washer Tubing
Internal Dia.	3mm
Material	Plastic
Quantity	Per Metre
Part No	GWW201M
Price (per metre)	£0.95



Description	Washer Tubing
Internal Dia.	4mm
Material	Plastic
Quantity	Per Metre
Part No	GWW202M
Price (per metre)	£0.85



Description	T Piece
Internal Dia.	3mm
Material	Plastic
Part No	GWW404
Price (ea)	£1.43



Description	T Piece
Internal Dia.	4mm
Material	Plastic
Part No	GWW401
Price (ea)	£1.02



Description	T Piece, 1 Way Valve
Internal Dia.	3mm
Material	Plastic
Part No	GWW408
Price (ea)	£3.95



Description	T Piece, 1 Way Valve
Internal Dia.	4mm
Material	Plastic
Part No	GWW407K
Price	£3.25



Description	Inline, 1 Way Valve
Internal Dia.	4mm
Material	Plastic
Part No	GWW504
Price (ea)	£1.96



Description	Foot, 1 Way Valve
Internal Dia.	4mm
Material	Plastic
Part No	GWW506
Price (ea)	£1.66

Washer Bottles



Description	Washer Bottle
Bottle Shape	Oblong
Bottle Material	Plastic
Capacity	TBA
H x W x D	72 x 125 x 87mm
Part No	GWW901
Price (ea)	£20.95



Description	Washer Bottle
Bottle Shape	D Shape
Bottle Material	Plastic
Capacity	TBA
H x W x D	160 x 110 x 87mm
Part No	GWW906
Price (ea)	£13.96



Description	Washer Bottle
Bottle Shape	Oval
Bottle Material	Plastic
Capacity	TBA
H x W x D	126 x 124mm
Part No	GWW917
Price (ea)	£13.96

Washer Bottle Caps



Description	Cap
Fitting Type	Push Fit
Material	Plastic
Fits Bottle	GWW917, GWW906, GWW901
Part No	GWW951
Price (ea)	£1.70



Description	Cap
Fitting Type	Screw Fit, 50mm OD
Material	Plastic
Fits Bottle	GWW918
Part No	AHH6848
Price (ea)	£3.95



Description	Cap
Fitting Type	Screw Fit
Material	Plastic
Fits Bottle	GWW901
Part No	GWW952
Price (ea)	£1.96

Washer Pump

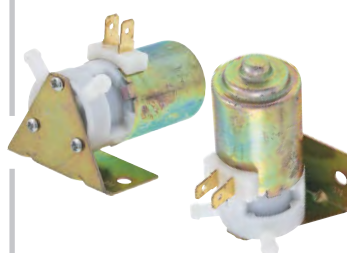

Description	Washer Pump
Type	Electric
Material	Metal
H x W x D	65 x 50 x 45mm
Voltage	12V
Part No	GWW125
Price (ea)	£10.96



Description	Washer Pump
Type	Manual
Material	Plastic
H x W x D	126 x 140 x 110mm
Voltage	N/A
Part No	GWW102
Price (ea)	£21.95

Washer Bottle Brackets



Description	Bracket
Material	Steel
Fits	GWW918K
Part No	13H232
Price (ea)	£5.45



Description	Bracket
Material	Stainless Steel
Fits	GWW918K
Part No	13H232SS
Price (ea)	£6.95



Description	Bracket
Material	Steel
Fits	GWW917
Part No	BHA4919
Price (ea)	£7.95



Description	Bracket
Material	Steel
Fits	GWW906
Part No	CZH1624
Price (ea)	£5.05

Washer Jet



Description	Washer Jet
Outlet Type	Twin
Material	Metal
Finish	Chrome
Part No	GWW801
Price (ea)	£3.76



Description	Washer Jet
Outlet Type	Single
Material	Metal
Finish	Chrome
Part No	GWW802
Price (ea)	£2.95



Description	Washer Jet
Outlet Type	Single
Material	Plastic
Finish	Black
Part No	GWW829
Price (ea)	£1.96

Wipers & Washers - WIPER ARMS

Wiper Arms

Wipers are an absolute necessity for your car. We offer a wide selection of different types of wiper arms and blades in various lengths to suit all applications. Choose either a black or bright finish.

Blade Fitting	Spindle Type	Spindle Fitting	Arm Length (Pivot to tip)	Arm Width	Bend	Finish	Part No	Price (ea)
Spoon	Plain	Collet, 1/4" Bottom Nut	180mm	5.2mm	Straight	Bright	161-050	£17.95
Spoon	Splined	Clip	203mm	5.2mm	LH	Bright	13H66	£10.94
Spoon	Splined	Clip	203mm	5.2mm	RH	Bright	13H68	£12.90
Spoon	Splined	Wedge	210mm	5.2mm	RH	Bright	BHA4893	£14.35
Spoon	Splined	Wedge	210mm	5.2mm	LH	Bright	BHA4894	£14.35
Spoon	Splined	Collet	220mm	5.2mm	LH	Bright	107963	£22.96
Spoon	Splined	Collet	220mm	5.2mm	RH	Bright	107965	£17.45
Spoon	Splined	Clip	230mm	5.2mm	RH	Bright	114488	£13.66
Spoon	Splined	Clip	230mm	5.2mm	LH	Bright	114485	£13.75
Rubber Clip	Plain	Collet, 1/4" Bottom Nut	193-260mm	5.2mm	RH	Bright	4G4840	£25.96
Rubber Clip	Plain	Collet, 1/4" Bottom Nut	193-260mm	5.2mm	LH	Bright	4G4839	£25.96
Bayonet	Splined	Clip	203mm	5.2mm	RH	Bright	BHA5207	£12.35
Bayonet	Splined	Clip	203mm	5.2mm	LH	Bright	BHA5208	£12.35
Bayonet	Splined	Wedge	227-285mm	7.2mm	LH	Bright	BHA4914S	£14.95
Bayonet	Splined	Wedge	234-285mm	5.2mm	LH	Bright	37H4952	£13.66
Bayonet	Splined	Clip	243mm	7.2mm	LH	Black	BHA5201Z	£12.95
Bayonet	Splined	Clip	275mm	7.2mm	LH	Black	BHA5205Z	£15.46
Bayonet	Splined	Clip	275mm	7.2mm	LH	Bright	151886Z	£15.35
Bayonet	Splined	Clip	278mm	5.2mm	RH	Bright	131108	£17.95
Bayonet	Splined	Clip	280mm	7.2mm	RH	Black	159684Z	£27.95
Bayonet	Splined	Clip	280mm	7.2mm	RH	Black	159684	£13.79
Bayonet	Splined	Clip	280mm	7.2mm	RH	Bright	151887Z	£15.95



Vintage Rod Link Type Wiper Arms

Early style of wiper arms usually with one motor and a link rod to operate opposite wiper arm. All arms are straight with the link rod bracket. Can be used on spindles at to or bottom of screen.

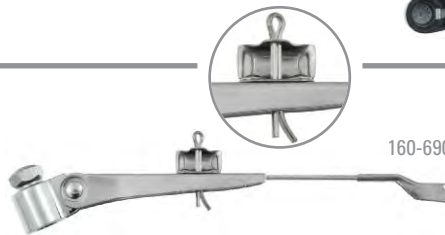

Blade Fitting	Spindle Type	Spindle Fitting	Arm Length (Pivot to tip)	Arm Width	Bend	Finish	Part No	Price (ea)
Rubber Clip	Plain	Collet, 3/16" Bottom Nut	130mm	5.2mm	Straight	Bright	160-700	£20.40
Rubber Clip	Plain	Collet, 3/16" Bottom Nut	130mm	5.2mm	Straight	Bright	160-800	£20.40
Rubber Clip	Plain	Collet, 3/16" Top Nut	130mm	5.2mm	Straight	Bright	160-690	£20.40
Rubber Clip	Plain	Collet, 3/16" Top Nut	130mm	5.2mm	Straight	Bright	160-790	£20.40

Wiper Motor

We offer wiper motors on a new or reconditioned basis. Due to the scarcity of core units we can only offer a 'Customer's Own Unit' rebuild service.



LIBRARY IMAGE

Description	Wiper Motor
Detail	CRT
Speed	Single
Rebuilt/New	Rebuilt
With Gear	No
Voltage	12V
Part No	501684R
Price (ea)	£150.95



LIBRARY IMAGE

Description	Wiper Motor
Detail	Lucas DR2
Speed	Single
Rebuilt/New	Rebuilt
With Gear	No
Voltage	12V
Part No	LULRW113R
Price (ea)	£155.95



LIBRARY IMAGE

Description	Wiper Motor
Detail	Lucas DR3
Speed	Twin
Rebuilt/New	Rebuilt
With Gear	No
Voltage	12V
Part No	514821R
Price (ea)	£153.95



Description	Wiper Motor
Detail	Lucas DR3A
Speed	Single
Rebuilt/New	Rebuilt
With Gear	No
Voltage	12V
Part No	GXE7714
Price (ea)	£153.951

Wipers & Washers - WIPER BLADES



Fitting Type	Overall Length	Mount fr. Bottom	Fitting Size	Finish	Qty.	Part No	Price (ea)
Spoon	8"	4"	5.2mm	Bright	1	GWB215	£7.96
Spoon	9"	4.5"	5.2mm	Bright	1	GWB145	£7.96
Spoon	9"	4.5"	5.2mm	Bright	1	GWB145Z	£6.50
Spoon	11"	5.5"	5.2mm	Bright	1	GWB146	£10.50
Spoon	7"	3.5"	N/A	Bright	1	160-900	£8.52
Spoon	8"	4"	N/A	Bright	1	114486	£6.95
Spoon	10"	5"	N/A	Bright	1	011-289	£3.55
Bayonet	9"	4.5"	5.2mm	Black	1	GWB266Z	£10.32
Bayonet	10"	5"	7.2mm	Black	1	GWB349Z	£11.35
Bayonet	11"	5.5"	7.2mm	Black	1	GWB350	£11.95
Bayonet	11"	5.5"	7.2mm	Black	1	GWB180Z	£17.40
Bayonet	12"	6"	7.2mm	Black	1	GWB199Z	£13.96
Bayonet	9"	4.75"	5.2mm	Bright	1	GWB164	£7.96
Bayonet	10"	5"	5.2mm	Bright	1	GWB219	£7.45
Bayonet	10"	5"	5.2mm	Bright	1	GWB219Z	£6.90
Bayonet	10"	5"	7.2mm	Bright	1	GWB141	£11.20
Bayonet	10"	5"	7.2mm	Bright	1	GWB141Z	£9.16
Bayonet	11"	5.5"	7.2mm	Bright	1	GWB118Z	£12.14
Bayonet	11"	5"	5.2mm	Bright	1	GWB223	£9.55
Bayonet	12"	6"	7.2mm	Bright	1	GWB168	£8.95
Bayonet	12"	6.5"	5.2mm	Bright	1	GWB142Z	£10.55
Bayonet	13"	6.5"	7.2mm	Bright	1	GWB245S	£12.70
Bayonet	13"	7"	7.2mm	Bright	1	GWB144Z	£11.86
Rubber Peg	7"	3.5"	N/A	Bright	1	160-300	£6.76
Rubber Peg	8"	4"	N/A	Bright	1	2H9381	£9.95
Rubber Peg*	N/A	N/A	N/A	N/A	1	160-400	£0.95
*To fit rubber peg wiper blades to arms.							
Multi Fit	11"	5.5"	N/A	Black	1	GWB911	£5.80
Multi Fit	13"	6.5"	N/A	Black	1	GWB913	£6.95
Multi Fit	14"	7"	N/A	Black	1	GWB914	£6.55
Multi Fit	16"	8"	N/A	Black	1	GWB916	£6.95
Multi Fit	17"	8.5"	N/A	Black	1	GWB917	£7.45
Multi Fit	18"	9"	N/A	Black	1	GWB918	£5.86
Multi Fit with Spoiler	18"	9"	N/A	Black	1	GWB918S	£19.96
Multi Fit	19"	9.5"	N/A	Black	1	GWB919	£9.95
Multi Fit	20"	10"	N/A	Black	1	GWB920	£9.16
Multi Fit	22"	11"	N/A	Black	1	GWB922	£11.86

WIPER RACK & TUBE



Description Wiper Rack, Cut to Fit
Length (in) 59"
Length (mm) 1498.6mm
Part No RTC202A
Price (ea) £9.95



Description Wiper Rack Outer Tube, Cut to Fit
Length (in) 35"
Length (mm) 900mm
Part No AAU1909A
Price (ea) £17.70



160-400

Wiper Motor Parts

New brushes can preserve the life of the wiper motor and help it run more effectively.



Description Wiper Motor
Detail 14W
Speed Twin
Rebuilt/New New
With Gear No
Voltage 12V
Part No GXE7708
Price (ea) £45.50

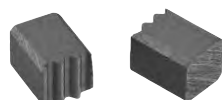

Description Brush Set
Application DR2, DR3, DR3A, CRT
Part No 508170
Price (ea) £6.35

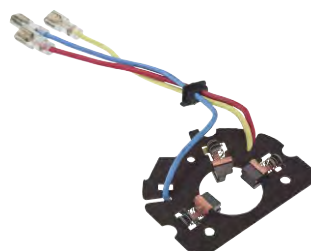

Description Brush, Gear & Plate Set
Application 14W
Part No RTC198A
Price (ea) £11.95

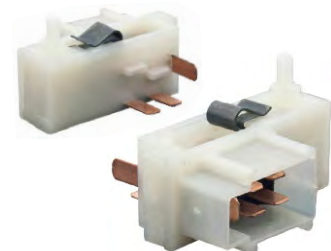

Description Park Switch
Application 14W
Part No 520160A
Price (ea) £19.96

Notification of prices

Due to the volatility of world markets and currency fluctuations the prices in this catalogue are subject to change. Moss make every attempt to keep prices competitive and stable, however in common with all other suppliers in our industry, we reserve the right to alter these prices without prior notice.

For the latest prices, please visit our website www.moss-europe.co.uk. All prices are per unit (unless otherwise stated) and include (UK) VAT at 20% (where applicable) and are correct at the time of going to print. Postage and packaging is not included. E&OE. Where the price is replaced with the word "£Call" this part is generally not available or only available to order. Please call our sales staff as we may be able to assist you in locating the part or a suitable replacement part.

Product supersessions

Moss Europe's policy is to detail the most up to date part information in our catalogues. Where possible parts are kept to original specification. However, in some instances we have to supersede to the most viable alternative product to maintain supply and keep cars on the road. Every effort is made to ensure high quality products.

UK ordering

We accept orders by mail, telephone, e-mail, fax and on-line at www.moss-europe.co.uk. If you have the opportunity, we invite you to visit one of our branches. Remember, supplying details of your car, (i.e. engine, commission or Vehicle Identification Number (VIN) LHD or RHD, year of manufacture and any modifications) saves time and helps us to help you. Please inform us of your customer number, as this will speed up the processing of your order.

Overseas ordering

We accept orders by mail, telephone, e-mail, fax and on-line at www.moss-europe.co.uk. If you visit the U.K. please come and visit one of our branches. When ordering, please ensure that you enclose full details of your name, address and customer number, plus details of your car (i.e. engine, commission or Vehicle Identification Number (VIN) LHD or RHD, year of manufacture and any modifications).

Please note: Overseas orders are often subject to local import duties, taxes and Customs clearance, which will need to be paid for at the point of entry. These charges are NOT included in the price of the goods or delivery prices. All relevant Customs forms and documentation needed to ensure the order arrives with the minimum of delay, will be included with your shipment. If you have any special requirements, please contact us to discuss them. Delivery charges are dependent upon the size and weight of the shipment. If a quotation is required prior to placing an order, please contact the export department at your chosen branch and they will be pleased to supply a full quotation.

Parts back-order system

A back-order system is used when a part is not in stock at the time of ordering. If the item is expected to become available within 6 months, then it will be put on back-order, unless the customer instructs us otherwise. When we have the parts in stock, the back-order will be processed automatically and the item will be dispatched to the customer. If the particular part becomes No Longer Available (NLA) or does not become available within 6 months the back-order will be cancelled. If you are unsure when you placed a back-order contact your local branch.

Dispatch & delivery methods

Orders for delivery in the UK may be dispatched by regular post (for small/lightweight items), or through a Next Day courier. Please contact us for the best delivery option for your order. We are constantly striving to improve the service we offer, so please contact us for the latest delivery prices. For delivery outside the UK we offer the following services:

- **Economy delivery (by road):** 2 to 5 days.
- **Express delivery (by air):** 1 to 2 days (Guaranteed) - next day service to most countries.
- **For small and low value orders we also use airmail.**

For these services, please ask for prices and the best delivery option when you place your order. Most deliveries (except airmail) are 'trackable', (inc: e-mail updates and internet access for selected carriers). Please remember, all carriage charges are dependent on weight band, volume, destination and delivery time. If a quotation is required prior to placing your order, please contact a member of the sales department. Alternatively, you can arrange your own delivery and dispatch.

Windscreen delivery information

We always suggest that windscreens should be collected from one of our branches to ensure you are able to transport your glass with the utmost of care. However, we understand that this is not always possible.

To minimise the possibility of damage to the windscreen in the shipping process, it is now Moss Europe's policy to ship windscreens packed in a specially designed heavy duty 'Tri-Wall' cardboard box. The price of this box is £35.00 (inc VAT), non-refundable and is included in the price of the product. The crate's dimensions will also increase shipping costs, particularly in EU countries. The crate dimensions are 150cm x 33cm x 74cm. The maximum volumetric weight is 92kgs. For more information please contact your nearest Moss branch.

Hazardous goods delivery information

At the time of going to print, Moss Europe Ltd conforms to international shipping regulations regarding packaging and transportation of Hazardous Goods by road and sea freight (only).

Due to these international shipping regulations and licencing rules all goods deemed as Hazardous are currently available for shipping to the UK and Europe only. If you place an order containing Hazardous goods and your shipping address is not in the UK or Europe, we will not be able to ship this item to you. Please contact your local branch or visit our website www.moss-europe.co.uk for the latest delivery information of Hazardous goods.

Quotations & payment methods

We will be pleased to provide a full parts quotation detailing price, availability and relevant shipping costs. Payment may be made by cash, personal cheque (to the card guarantee limit), Certified Bank Draft, Sterling Travellers Cheques and credit or debit card including: Mastercard, Visa, Delta. If you intend to make payment by Cheque or Bankers Draft when using our fast mail-order parts service, please confirm parts availability and carriage charges.

We can accept payments using PayPal for email and phone orders only.

Value added tax (VAT)

Value Added Tax (VAT) at the current rate will be levied on all orders being dispatched to all countries within the European Community. EU countries may be charged at their local VAT rate, please contact us or see website for details. VAT is not charged on goods dispatched to countries outside of the EU. However, such orders are often subject to local import duty, taxes and Customs clearance, which MUST be paid by you at the port of entry. Such charges are not included in the cost of the goods or delivery prices.

Exchange units

We are able to offer a full rebuild service on numerous major components in our product range. We offer this service as an alternative to direct replacement parts, or when a brand new item is no longer available. However, the continuity of this exchange scheme needs the understanding and co-operation of our customers in relation to several important points: It is important to remember that "rebuild" does not mean "brand new". Rebuilding a unit involves stripping, cleaning, inspecting and re-assembling the unit. During this process, parts showing signs of wear will either be completely replaced or suitably renovated. However, it is not always feasible for major sub-components to be replaced with brand new ones, for example, an exchange engine will not have a new block. Due to the nature of certain product lines, some items can only be offered on a "one for one" exchange basis. This effectively means that you must offer us a viable unit before we can release a fully rebuilt item from our stock. In some instances we can only carry out reconditioning of your own unit. Our staff will inform you if this is the case.

All exchange units are subject to a surcharge. This surcharge serves two purposes; firstly, it acts as an incentive for you to return your old unit, and secondly it provides us with financial cover if your returned unit proves unsuitable for exchange purposes.

Whether or not your returned unit is suitable for exchange purposes cannot be ascertained until it is made available to us for inspection. As a general rule, suitable for exchange basically excludes any items that are beyond reasonable repair (e.g. crankcases pierced by a connecting rod) or units irrevocably damaged. We are also unable to accept units unless they are returned in whole, complete form (i.e. differential units which are returned partly stripped with no bearings and all the shims missing are not generally accepted), nor do we accept a "box of bits".

Surcharges will only be refunded once our core department has passed the item as serviceable. Under no circumstances can any exchange unit be shipped overseas until we receive your original unit. We have predetermined prices for our exchange units based on our experience of repair costs for a gearbox, axle or engine. Occasionally, however, the damage to the unit is so great that we will contact you before beginning work on your unit to advise you of any additional cost that may be incurred during the rebuild of the unit. We can return the unit (at your cost) if this proves unacceptable.

'Old unit' returns

Exchange items including reconditioned engines are subject to a surcharge that is refunded when a rebuildable unit (core) is returned. When you receive the rebuilt unit, attached to it will be a Core Return Authorisation Tag. This tag must be removed from the rebuilt unit and attached to the returned core in order to receive credit. Cores must be returned within 90 days of purchase in the original box, carton or engine cradle supplied with the rebuilt unit. Cores must be shipped clean and empty of fluids. Cores must be complete, assembled and rebuildable to receive credit or refund. You must pay all shipping charges for the return of the core and these charges are not refundable.

Warranty

All parts are warranted against defects in materials and workmanship for a period of twelve (12) months from the date of purchase. The warranty does not cover failure resulting from incorrect installation or misuse; failure during any competition, motorsports or track events; failure of any, or caused by any, related component. The warranty does not cover labour charges, nor will a warranty settlement be greater than the cost of the original component. Should you need to make a warranty claim, please contact us immediately at the branch of purchase. We will then advise you as to the best course of action. With all warranty claims a copy of the original purchase invoice must be produced.

Warranty returns

Parts that fail in use may be returned for 12 months from the date of purchase. Returns must be accompanied by the original invoice - no warranty claims will be paid without a copy of the original invoice. Return freight will be reimbursed. Electrical parts returned for warranty will be tested and if found functional, no return credit will be given and the part will be returned. Reimbursement is made by the original payment method. Complete the return form included in each order, pack the items securely and use the shipping return label supplied.

Non-warranty returns

All uninstalled parts, in their original packaging may be returned within 90 days for any reason. A copy of the original invoice or the picking label (which is generally attached to the original packaging) must accompany the return. Return freight is paid by the customer. If the return is due to our error, the return freight will be reimbursed. Parts returned outside of this policy or in non-resalable condition may not be accepted or may be assessed a 15% handling fee. Reimbursement is made by the original payment method. Complete the return form included in each order, pack the items securely and use the shipping return label supplied.

Customer service

We value your custom and wish to ensure that you receive the very best service. Every effort will be made to provide you with Quality Parts and Expertise in a relaxed, helpful and friendly manner. Should you consider the service you receive from us to be unsatisfactory, or you have any problems with the part(s) purchased, please advise a member of the sales team at the originating branch. If the matter is not resolved to your satisfaction, please e-mail our Customer Services Department at customerservices@moss-europe.co.uk or write to: **Customer Services, Moss Europe Ltd Unit 16, Hampton Business Park, Bolney Way, Feltham TW13 6DB England.** *We will do our very best to resolve the issue.*

British Motor Heritage

Moss Europe Ltd is a British Motor Heritage approved specialist.



General Hardware - NUTS, BOLTS & SCREWS

Bolts & Set Screws - Hexagon Headed

Size (UNF)	Length	Set screw	Price £ea	Bolt	Price £ea
1/4"	3/8"	SH604031	£0.74		
1/4"	1/2"	SH604041	£0.16		
1/4"	5/8"	SH604051	£0.16		
1/4"	3/4"	GHF117	£0.16		
1/4"	7/8"	SH604071	£0.30		
1/4"	1"	GHF101	£0.16		
1/4"	1 1/8"	SH604091	£0.95	BH604091	£0.46
1/4"	1 1/4"	SH604101	£0.30	BH604101	£0.25
1/4"	1 3/8"	SH604111	£0.90	BH604111	£0.46
1/4"	1 1/2"	SH604121	£0.70	GHF102	£0.25
1/4"	1 3/4"	SH604141	£0.46	BH604141	£0.70
1/4"	2"	SH604161	£0.40	GHF118	£0.35
1/4"	2 1/4"			BH604181	£0.52
1/4"	2 1/2"			BH604201	£0.80
1/4"	3"			BH604241	£0.85
5/16"	3/8"	SH605031	£0.60		
5/16"	1/2"	SH605041	£0.35		
5/16"	5/8"	SH605051	£0.40		
5/16"	3/4"	SH605061	£0.20		
5/16"	7/8"	SH605071	£0.60		
5/16"	1"	GHF103	£0.25		
5/16"	1 1/8"	SH605091	£0.55	BH605091	£0.46
5/16"	1 1/4"	SH605101	£0.55	BH605101	£0.50
5/16"	1 3/8"	SH605111	£0.80	BH605111	£0.50
5/16"	1 1/2"	SH605121	£0.70	GHF104	£0.46
5/16"	1 3/4"	SH605141	£0.80	BH605141	£0.80
5/16"	1 7/8"	SH605151	£0.72	BH605151	£0.95
5/16"	2"	SH605161	£0.76	BH605161	£0.65
5/16"	2 1/4"	SH605181	£0.85	BH605181	£0.74
5/16"	2 1/2"	SH605201	£1.06	BH605201	£0.74
5/16"	2 3/4"			BH605221	£0.60
5/16"	3"	SH605241	£0.95	BH605241	£0.65
3/8"	3/8"	SH606031	£2.40		
3/8"	1/2"	SH606041	£0.65		
3/8"	5/8"	SH606051	£0.55		
3/8"	3/4"	SH606061	£0.46		
3/8"	7/8"	SH606071	£0.46		
3/8"	1"	GHF105	£0.20		
3/8"	1 1/8"	SH606091	£0.90		
3/8"	1 1/4"	SH606101	£0.30	BH606101	£0.60
3/8"	1 3/8"	SH606111	£0.46	BH606111	£0.95
3/8"	1 1/2"	SH606121	£0.35	GHF106	£0.35
3/8"	1 3/4"	SH606141	£0.50	BH606141	£0.50
3/8"	2"	SH606161	£1.15	BH606161	£0.55
3/8"	2 1/4"			BH606181	£0.95
3/8"	2 1/2"	SH606201	£1.20	BH606201	£0.74
3/8"	2 3/4"			BH606221	£0.95
3/8"	3"	GHF126	£0.85		
3/8"	3 1/2"	BH606281	£0.95		
3/8"	4"	BH606321	£1.20		
7/16"	5/8"	SH607051	£2.95		
7/16"	3/4"	SH607061	£0.35		
7/16"	7/8"	SH607071	£0.40		
7/16"	1"	SH607081	£0.55		
7/16"	1 1/8"	SH607091	£1.55		
7/16"	1 1/4"	SH607101	£1.50		
7/16"	1 3/8"	SH607111	£1.40		
7/16"	1 1/2"	GHF107	£0.50	BH607121	£0.60
7/16"	1 3/4"	SH607141	£1.60	BH607141L	£1.06
7/16"	2"	SH607161	£0.95	BH607161	£0.76
7/16"	2 1/4"			BH607181	£0.76
7/16"	2 1/2"			BH607201	£0.85
7/16"	3"			BH607241	£0.70
1/2"	1/2"	SH608041	£1.96		
1/2"	1"	SH608081	£1.45		
1/2"	1 1/2"	GHF109	£0.85		
1/2"	1 3/4"	SH608141	£1.60	BH608141	£1.40
1/2"	2"			BH608161	£1.15
1/2"	2 1/4"			BH608181	£0.95
1/2"	2 1/2"			BH608201	£0.76
1/2"	3"			BH608241	£1.60

Studs

Diameter	Overall length	Part number	Price £ea
1/4"	1 3/8"	NKC56	£2.90
1/4"	1 1/4"	FHS2410	£0.65
5/16"	1 1/4"	TE605105	£1.45
5/16"	1 1/2"	FHS2512	£0.76
5/16"	1 5/8"	FHS2513	£0.76
5/16"	1 3/4"	TE605141	£1.45
5/16"	1 7/8"	FHS2515	£0.70
5/16"	2 1/4"	FHS2518	£2.10
5/16"	2 1/2"	FHS2520	£1.36
3/8"	1 3/8"	105124	£0.85
3/8"	1 3/4"	FHS2614	£2.95

Nuts

Thread size (UNF)	Spanner size	Full nut	Price £ea	Half nut	Price £ea
No. 6	5/16"	NH806011	£0.14		
3/16"	3/8"	HN2005	£0.06		
3/16"	5/16"	GHF206	£0.05		
1/4"	7/16"	GHF200	£0.10	JN2107	£0.16
5/16"	1/2"	GHF201	£0.10	NT605041	£0.16
3/8"	9/16"	GHF202	£0.10	NT606041	£0.40
7/16"	5/8"	GHF203	£0.16	JN2110	£0.30
1/2"	3/4"	GHF204	£0.18	FNZ208	£0.35
9/16"	7/8"			53K320	£0.90
5/8"	15/16"			NT610041	£0.50

Nyloc self locking

Thread size (UNF)	Spanner size	Full nut	Price £ea	Half nut	Price £ea
3/16"	5/16"	GHF220	£0.10		
1/4"	7/16"	GHF221	£0.20	GHF271	£0.20
5/16"	1/2"	GHF222	£0.35	GHF272	£0.35
3/8"	9/16"	GHF223	£0.35	GHF273	£0.20
7/16"	5/8"	GHF224	£0.30	GHF274	£0.55
1/2"	3/4"	GHF225	£0.46	GHF275	£0.55
9/16"	7/8"	252165	£1.36	TN3212	£0.76
5/8"	15/16"	GHF226	£0.95	53K1667	£0.95

Self locking, 'aero'

Thread size (UNF)	Spanner size	Full nut	Price £ea
1/4"	7/16"	LNZ104	£1.30
5/16"	1/2"	LNZ105	£0.50
3/8"	9/16"	LNZ106	£1.10
7/16"	5/8"	LNZ107	£1.36
1/2"	3/4"	LNZ108	£0.95

Plain brass

Thread Size (UNF)	Spanner Size	Full Nut	Price £ea
5/16"	1/2"	GHF261	£0.35
3/8"	9/16"	GHF262	£0.95
3/8"	9/16"	108951	£1.75

Washers

Hole size	External star	Price £ea	Internal star	Price £ea
3/16"	WE702101	£0.16	WF702101	£0.20
1/4"	WE600041	£0.25	GHF321	£0.10
5/16"	WE600051	£0.20	GHF322	£0.10
3/8"	WE600061	£0.30	GHF323	£0.10
7/16"	WE600071	£0.11	GHF324	£0.10
1/2"	WE600081	£0.25	GHF325	£0.20
5/8"	WE600101	£0.30		

Spring

Hole size	Single coil	Price £ea	Double coil	Price £ea
No. 6	WL700061	£0.12		
No. 8	WL700081	£1.10		
3/16"	WL700101	£0.10	AJD7721	£0.20
1/4"	GHF331	£0.10	AJD7722	£0.20
5/16"	GHF332	£0.16	AJD7731	£0.40
3/8"	GHF333	£0.16	WS600061	£1.66
7/16"			GHF334	£0.20
1/2"			GHF335	£0.20
5/8"			LWZ310	£0.50

Plain

Hole size	Standard type	Price £ea	Repair type	Price £ea
No. 6			WP3	£0.20
No. 8			WP4	£0.16
3/16"	GHF306	£0.16	WP5	£0.08
1/4"	GHF300	£0.10	GHF314	£0.10
5/16"	GHF301	£0.10	GHF315	£0.10
3/8"	GHF302	£0.25	GHF316	£0.46
7/16"	GHF303	£0.16	WMM69	£0.72
1/2"	GHF304	£0.10		
9/16"			WA600091	£0.25
5/8"			PWZ110	£0.40

Screws

Cross Slot

Size (UNF)	Length	Countersunk headed	Price £ea	Pan headed	Price £ea
No. 10	1/4"			PMZ304	£0.20
No. 10	5/16"	CMZ305	£0.30	PMZ305	£0.20
No. 10	3/8"	CMZ306	£0.25	PMZ306	£0.25
No. 10	7/16"	CMZ307	£0.25	PMZ307	£0.20
No. 10	1/2"	CMZ308	£0.16	PMZ308	£0.17
No. 10	5/8"	CMZ310	£0.16	SE910201	£0.35
No. 10	3/4"	CMZ312	£0.46	PMZ312	£0.35
No. 10	7/8"			PMZ314	£0.40
No. 10	1"	CMZ316	£0.30	PMZ316	£0.35
1/4"	1/2"	SF604041	£0.19	SE604041	£0.25
1/4"	5/8"	SF604051	£0.20	SE604051	£0.25
1/4"	3/4"	SF604061	£0.25	SE604061	£0.30
1/4"	1"	SF604081	£0.30	SE604081	£0.35
1/4"	1 1/2"	SF604121	£0.76	SE604121	£0.76
1/4"	1 3/4"	CMZ428	£0.48		
5/16"	3/4"	SF605061	£0.50	SE605061	£0.85
5/16"	1"	SF605081	£0.35	SE605081	£0.50

Self tapping

Size	Length	Countersunk headed	Price £ea	Pan headed	Price £ea
No. 4	1/4"			AB604023	£0.30
No. 6	1/4"			AB606021	£0.17
No. 6	3/8"			AB606031	£0.17
No. 6	1/2"	GHF400	£0.07	GHF421	£0.07
No. 6	3/4"	GHF401	£0.16	GHF422	£0.25
No. 6	1"	AC606081	£0.12	AB606081	£0.12
No. 8	1/2"	GHF402	£0.14	GHF423	£0.14
No. 8	3/4"	GHF403	£0.14	GHF424	£0.10
No. 8	1"			AB608081	£0.25
No. 10	1/2"	GHF404	£0.28	GHF425	£0.10
No. 10	3/4"	GHF405	£0.17	GHF426	£0.10
No. 10	1"	AC610081	£0.25	AB610081	£0.20
No. 12	1/2"	AC612041	£0.25		
No. 12	3/4"			GHF428	£0.10
No. 12	1"	AC612081	£0.30	GHF429	£0.25
No. 14	3/4"	AC614061	£0.35	AB614061	£0.70
No. 14	1"	AC614081	£0.35	GHF431	£0.20

Spring/Spire Nuts

Screw size	Flat type	Price £ea	'U' type	Price £ea
No. 6	GHF700	£0.30	GHF711	£0.16
No. 8	GHF701	£0.16	GHF712	£0.18
No. 10	GHF702	£0.26	GHF713	£0.25
No. 12			GHF714	£0.62

EUROPE'S CLASSIC MOTOR OIL



Dynolite offers a broad range of oils and lubricants for Veteran, Vintage and Classic cars and motorbikes. Dynolite lubricants are blended to exceed the original vehicle manufacturer's specifications. They are formulated from high quality components and are only combined with additives specially selected for their compatibility with metals and components used in older vehicles, including suitable levels of ZDDP to combat wear, often reduced in modern oil blends. Most modern oils do not cater for these older technologies.

Dynolite's philosophy stands out for its range, offering specific lubricants for engines, gearboxes, steering boxes, as well as greases. In terms of mechanical protection, Dynolite lubricants are far superior to those usually found on the market for the simple reason that they have been specially developed for your historic vehicle. Therefore, you benefit from increased protection, higher oil pressure combined with a lower degree of acid attack and corrosion, reducing gum and sludge formation.

See the Moss 2014 Restoration Tools catalogue for details of the full range of Dynolite oils and lubricants.

DYNOLITE

EUROPE'S CLASSIC MOTOR OIL



BRISTOL

'Moss Bristol' is one of five Moss Europe Ltd branches located across the UK and Europe. Nestled in the heart of the south west, Moss Bristol is run by enthusiasts for enthusiasts, catering for the classic British models that Moss have become renowned for. However...

...we realised with over 45,000 parts in stock that not all of them have been available through our famous 'model' parts catalogues. To rectify this we have been cataloging our full parts inventory, this catalogue is the result. Obviously there are not 45,000 parts featured in this first edition. However, we hope to keep adding useful parts and developing the catalogue for years to come.

Having an in-depth knowledge of these components allows us to offer you parts by specification, size, material, fitting... rather than by their original application. Allowing you to maintain originality or customise your vehicle by choosing the parts you like.

So whether it's a set of lamps for your classic Ford or Kit Car, or a selection of bulbs for a 1970's Vauxhall, you will be surprised which parts will fit your car without resorting to secondhand parts.



...as seen on BBC's
"The One Show"



LONDON

LONDON

Unit 16, Hampton Business Park
Bolney Way, Feltham
TW13 6DB

London Tel
+44 (0) 20 8867 2020

E-mail
sales@moss-europe.co.uk

Fax
+44 (0) 20 8867 2030



BRADFORD

BRADFORD

Unit 12-13, Acorn Park Ind. Est.
Otley Road, Shipley
BD17 7SW

Bradford Tel
+44 (0) 1274 539 999

E-mail
bradford@moss-europe.co.uk

Fax
+44 (0) 1274 539 990



BRISTOL

BRISTOL

1-3 Elton Street
Bristol
BS2 9EH

Bristol Tel
+44 (0) 117 923 2523

E-mail
bristol@moss-europe.co.uk

Fax
+44 (0) 117 942 8236



MANCHESTER

MANCHESTER

111-117 Stockport Road
Stockport, Cheshire
SK3 0JE

Manchester Tel
+44 (0) 161 480 6402

E-mail
manchester@moss-europe.co.uk

Fax
+44 (0) 161 429 0349



PARIS

PARIS

7 rue Chaponval
ZAC du Cornouiller
78870 Bailly, France

Paris Tel
+33 (0) 1 30 80 20 30

E-mail
sales@moss-europe.fr

Fax
+33 (0) 1 30 80 21 50

Moss Website
moss-europe.co.uk

ebay
stores.ebay.co.uk/moss-europe-ltd

Facebook
facebook.com/mosseurope

Twitter
twitter.com/mosseurope

Moss Paris Website
moss-europe.fr